

# MAJESTIC

22 " FULL HD LED TV  
DVB-T / T2 HD ANALOGUE AND DIGITAL TUNER  
DVB-S / S2 HD SATELLITE TUNER  
RECORDING VIA USB INPUT  
MULTIMEDIA FILES PLAYBACK THROUGH USB  
COMPATIBLE WITH CAM CI + HD MODULE

**MODEL NO.: TVD222/S2 LED**



CE



Imported by. New Majestic S.p.A. Via Rossi Martini, 41, 26013 Crema (CR) – Italy

[www.newmajestic.com](http://www.newmajestic.com)

MADE IN EU

Please read this manual carefully before using,  
and keep it for future reference.

# SAFETY WARNING

## SAFETY INSTRUCTIONS

For safe use and maximum performance, please read this manual carefully before use.

**CAUTION: TO REDUCE THE RISK OF ELECTRIC SHOCK, DO NOT DISASSEMBLE THE APPLIANCE. THERE ARE NO USER SERVICEABLE PARTS. FOR REPAIRS CONTACT QUALIFIED TECHNICAL STAFF.**

To avoid the danger of electric shock or fire, do not expose to rain or moisture.



**DANGEROUS VOLTAGE!**



The symbol to the side warns the user of the presence of voltage that could not be isolated and may cause electric shock .



This symbol warns the user that before using the unit, it is necessary to carefully read the instruction booklet.

## IMPORTANT NOTES

The use must be allowed only to adults and responsible persons, adequately educated on the damages deriving from incorrect use.

This appliance can be used by children aged 8 and over if they are under supervision or if they have received instructions regarding the safe use of the appliance and if they understand the dangers.

involved. Cleaning and maintenance operations by the user must not be carried out by children unless they are over 8 years of age and operate under supervision. Keep the appliance and its cord out of the reach of children under the age of 8.

The devices can be used by people with reduced physical, sensory or mental abilities or with a lack of experience and knowledge if they are supervised or if they have received instructions regarding the safe use of the appliance and understand the dangers involved.

Children must not use the appliance as a game.

Do not allow the appliance to be used by children or the disabled without supervision

Keep away from pets

Never use the appliance in places where the cord, plug and the product itself may come into contact with water or wet surfaces. Do not use the appliance outdoors, as rain could create short circuits. Do not touch the appliance with wet hands.

Avoid installing the unit in the locations listed below:

-Places exposed to direct sunlight or close to equipment that generate heat, such as radiators;

-Above other stereo equipment that may radiate excessive heat;

-Places that block ventilation or are humid or dusty;

-Environments subject to constant vibration;

Do not place accessories with naked flames, such as lighted candles, on the appliance.

Do not try to repair or intervene on the appliance yourself. Incorrect interventions or tampering can void the guarantee. In the event of any damaged parts or suspected malfunction, discontinue use immediately and consult qualified personnel. Never immerse the appliance in water or other liquids. Do not place items containing liquids (such as vases) on top of the appliance.

Do not touch the appliance with wet hands and do not place it near sinks, tubs or containers of liquids.

Use the product only if it is in perfect condition. If the appliance has been immersed in water or is damaged, contact qualified personnel.

The product should not be used if it has been dropped or if there are any visible signs of damage.

Exposure to high volume levels can cause hearing problems, including permanent damage. The predisposition to hearing loss varies from person to person, however constant exposure to high volume levels is harmful to anyone. Moderate the volume level.



**CAUTION- TO REDUCE THE RISK OF PERSONAL INJURY OR PRODUCT/PROPERTY DAMAGE:**

- This product is intended solely for non-commercial, non-industrial, personal use as

a television. Do not use this product for any other purpose.

- Do not subject the product to violent shocks, extreme temperatures, or lengthy periods under direct sunlight.
- Keep the product away from magnetic objects, motors, and transformers.
- Do not use outdoors in inclement weather.
- Do not use the TV while driving; this is dangerous and is illegal in some areas.

## **BATTERY HANDLING AND USAGE:**

- Keep batteries away from children and pets. Only adults should handle batteries.
- Never throw batteries into a fire or expose them to fire or other heat sources.
- Follow the battery safety and usage instructions provided by the manufacturer.

## **ACCESSORIES**

User Manual.....	1
Remote Control.....	1
Car Adaptor.....	1

All the pictures in this manual are just for your reference, appearance and display should subject to the final product.

# TABLE OF CONTENTS

## **GETTING STARTED**

IMPORTANT INSTRUCTIONS.....	1-3
ACCESSORIES.....	3
FEATURES.....	5
GENERAL PARTS.....	6-7
REMOTE CONTROL.....	8-9
REMOTE CONTROL PREPARATION.....	10
BASIC CONNECTION.....	11-15

## **OPERATIONS**

BASIC OPERATIONS.....	16-20
MAIN MENU.....	21-34
FIRST TIME INSTALLATION.....	21
DTV MODE.....	23-30
ATV MODES.....	30
SATELLITE MODE.....	31
PC/VGA MODE.....	32

## **FOR REFERENCE**

MAINTENANCE.....	33
WALL MOUNTING.....	33
STAND INSTALLATION.....	34
SPECIFICATIONS.....	35-36
TROUBLESHOOTING.....	37

## FEATURES

**22" LED FULL HD Display**

**With Hotel Lock**

**Support Auto TV Scanning**

**Analogue tuner and DVB-T**

**DVB-S tuner**

**Support EPG (Electric Program Guide) Function**

**Support TELETEXT (Europe) Function**

**Support USB Multimedia Playback**

**Support Multi-languages On Screen Display**

**Support Full Function Remote Control**

**Support HDMI, SCART, YPBPR, VGA, PC AUDIO, AUDIO/VIDEO input.**

**CI+ (high definition contents playback supported)**

**Support EARPHONE and COAXIAL Output**

**With External Antenna Jack (DVB-T/DVB-S)**

**With Built-in Speakers**

# GENERAL PARTS

## MAIN UNIT

### Front View

### Side View

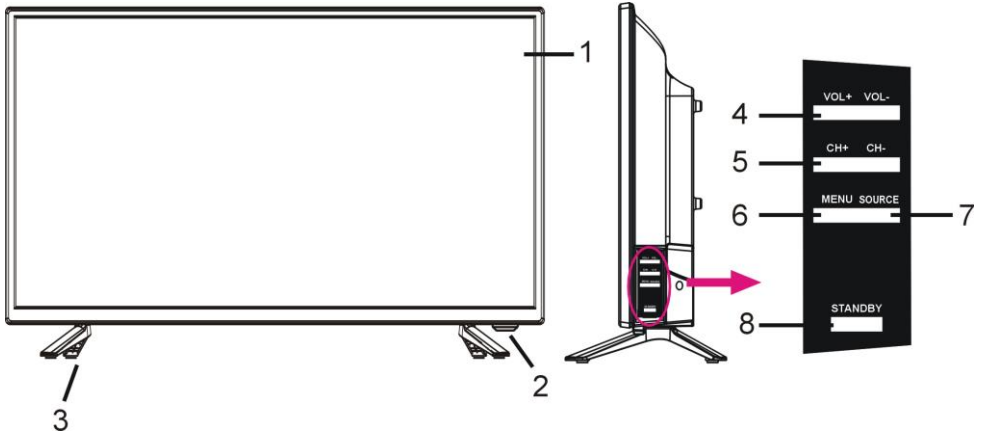

1. LED display screen
2. Remote control sensor. In standby mode the indicator light will display red color; when switching on the unit the indicator light will display blue color.
3. Stand holder
4. VOL +/- button- To increase/decrease the volume level or move left/right.
5. CH +/- button- To select next/previous channel or move up/down.
6. MENU button- To enter menu setting page.
7. SOURCE button- To select the input source.
8. STANDBY button- To turn ON/OFF the TV.

# GENERAL PARTS



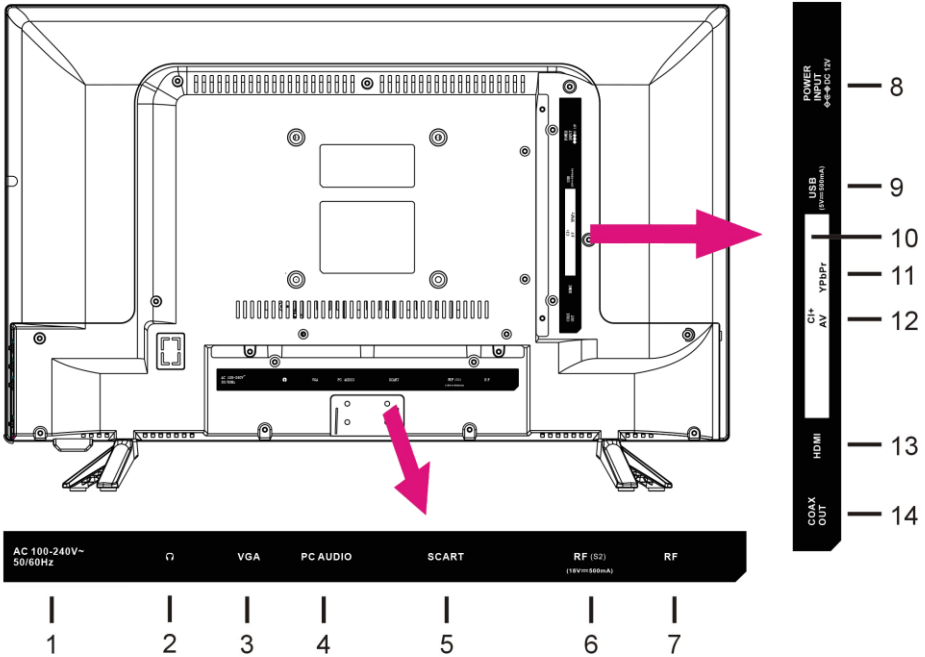

## Back View



1. Power input (AC)
2. EARPHONE output terminal
3. VGA input terminal
4. PC AUDIO input terminal
5. SCART input terminal
6. RF input terminal- To connect the external Satellite TV Antenna (DVB-S2).
7. RF input terminal- 75 ohm, To connect the external TV antenna (DTV \ ATV).
8. Power input (DC)
9. USB input terminal
10. CI input terminal (CI+ compatible)
11. Mini YPbPr input terminal (Component)
12. Mini AV input terminal
13. HDMI input terminal
14. COAXIAL output terminal



## REMOTE CONTROL

- 1 STANDBY**  
Set the unit in standby mode; press it again to switch it on.
- 2 TV/RADIO (DTV)**  
Switch the unit between TV and Radio.
- 3 RED button**
- 4 GREEN button**
- 5 BLUE button**
- 6 YELLOW button**
- 7 FAV**  
Display the favorite channels list.
- 8 TEXT**  
Display the available Teletext.
- 9 EPG (DTV)**  
Display electronic program guide.
- 10 HOLD**  
Hold the image on Teletext and TV.
- 11 SUBTITLE**  
Enable/disable subtitles.
- 12 SIZE**  
Switch Teletext size.
- 13 SUBPAGE**  
Enter Teletext sub-page.
- 14 ASPECT**  
Press it repeatedly to select desired screen size.
- 15 MEDIA**  
Enter Media (USB) mode directly.
- 16**   
Start/pause playing.
- 17**   
Move fast forward.
- 18**   
Move fast backward.
- 19**   
The function is not available.
- 20**   
Stop playing.

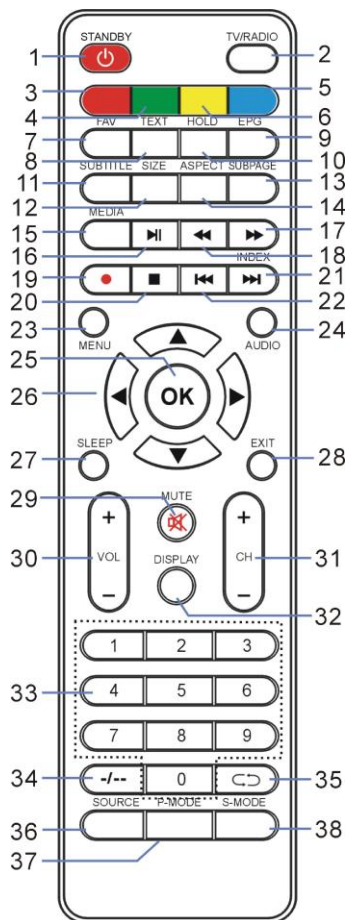

# REMOTE CONTROL

- 21 **▶▶**  
Play the next file.
- INDEX (DTV)**  
Display the record list or Teletext index.
- 22 **◀◀**  
Play the previous file.
- 23 **MENU**  
Call out the main menu or return to previous menu.
- 24 **AUDIO**  
Switch the available sound-track.
- 25 **OK**  
Confirm selection.
- 26 **▲/▼/◀/▶**  
Navigation buttons
- 27 **SLEEP**  
Set desired sleep time.
- 28 **EXIT**  
Exit the menu page.
- 29 **MUTE**  
Mute the sound.
- 30 **VOL +/-**  
Increase/decrease the volume level.
- 31 **CH +/-**  
Play the next/previous program.
- 32 **DISPLAY**  
Display the available program information.
- 33 **Number buttons (0-9)**  
Input the number information, such as channel number and so on.
- 34 **-/--**  
Switch the digit when watching TV programs.
- 35 **↶**  
Return to previous channel.
- 36 **SOURCE**  
Select desired input source.
- 37 **P-MODE**  
Switch the picture mode.
- 38 **S-MODE**  
Switch the sound mode.

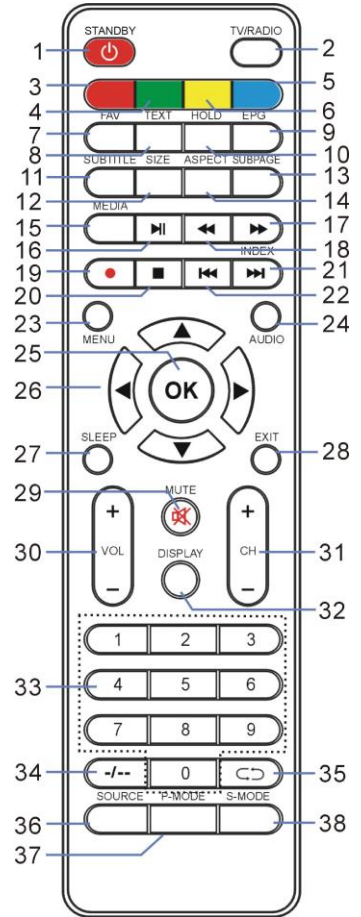

## REMOTE CONTROL PREPARATION

### BATTERY INSTALLATION

Install the batteries as the following picture. Be sure + and – terminals are positioned as indicated in the battery compartment (Fig1).

### SERVICE LIFE OF BATTERIES

- The batteries normally last for one year although this depends on how often the remote control is used.
- If the remote control fails to work even when it is operated near the player, replace the batteries.
- Use two size AAA dry batteries.

#### **NOTE:**

- Do not drop, step on or otherwise impact the remote control. This may damage the parts or lead to malfunction.
- If the remote control is not going to be used for a long time, remove the batteries.

## REMOTE CONTROL OPERATION

Point the remote control from no more than about 6m from the remote control sensor and within about 60° of the front of the player (Fig2).

#### **NOTES:**

- The operating distance may vary according to the brightness of the room.
- Do not point bright light at remote control sensor.
- Do not place objects between the remote control and the remote control sensor.
- Do not use this remote control while simultaneously operating the remote control of any other equipments.

**Fig1**

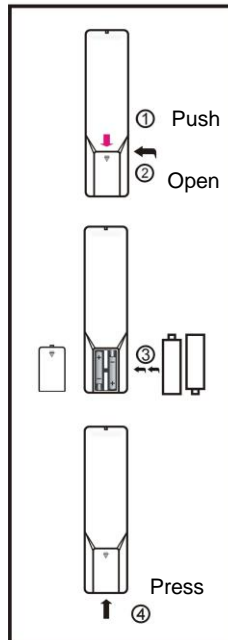

**Fig2**

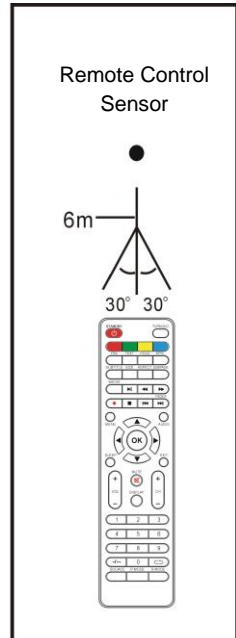

## BASIC CONNECTION

- Ensure all the cables are disconnected from the main unit before connecting to AC power source.
- Read through the instructions before connecting other equipments.

### CONNECTING TO AC POWER SOURCE

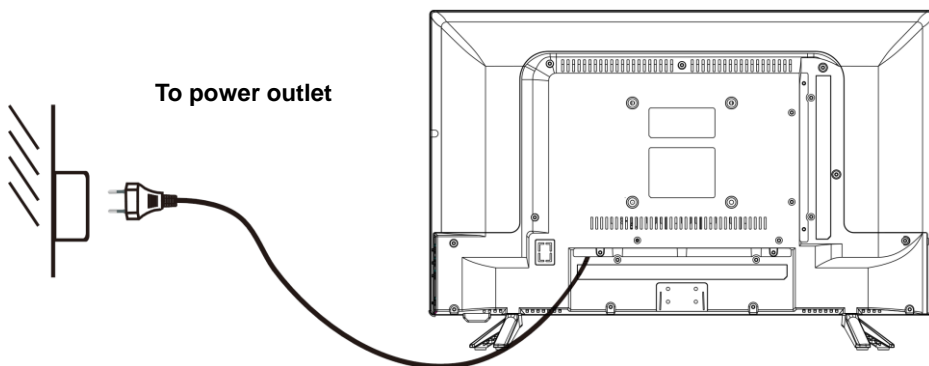

### CONNECT EXTERNAL ANTENNA TO UNIT

Install external antenna into antenna jack for best picture.

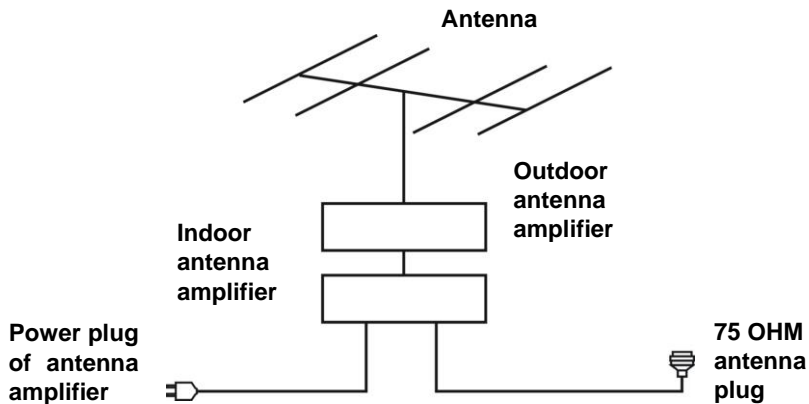

## HDMI CONNECTION

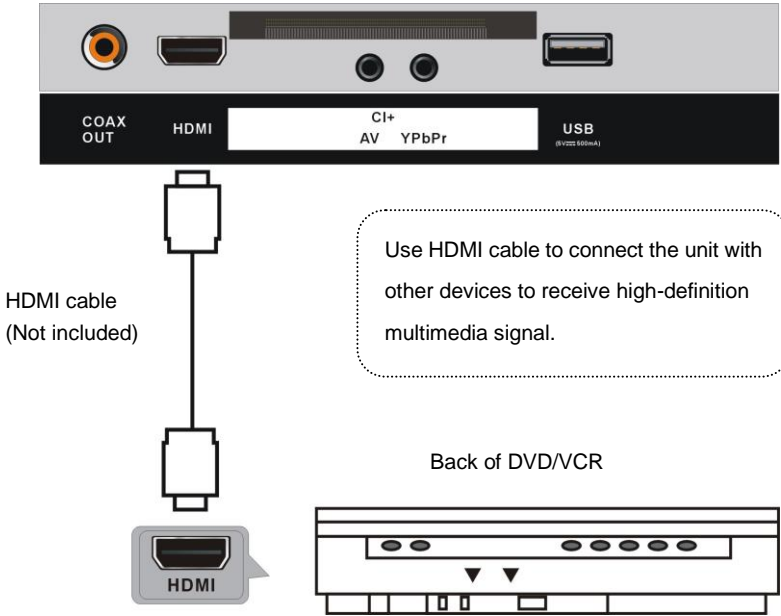

## PC/VGA CONNECTION

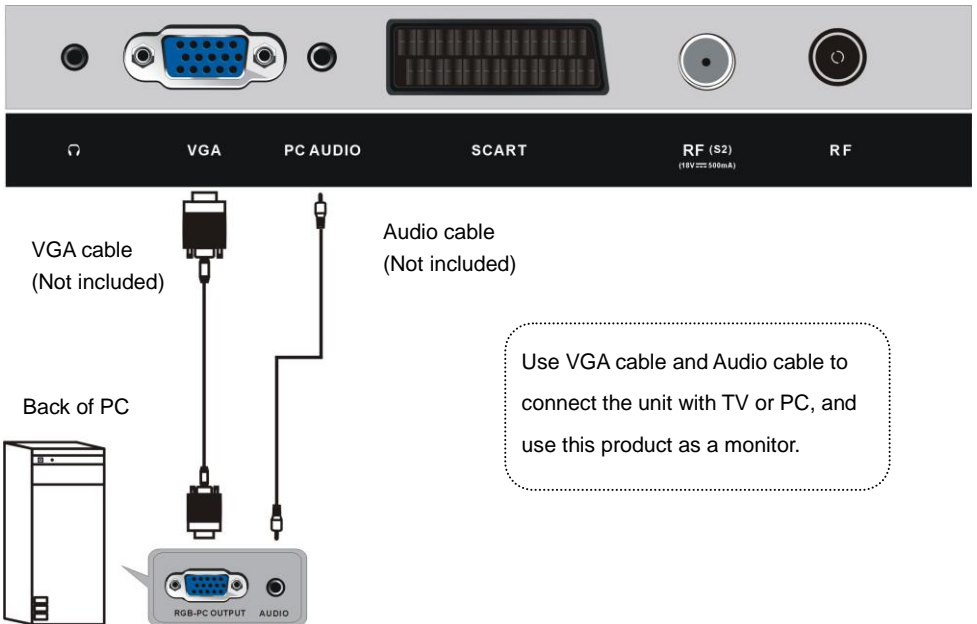

## SCART CONNECTION

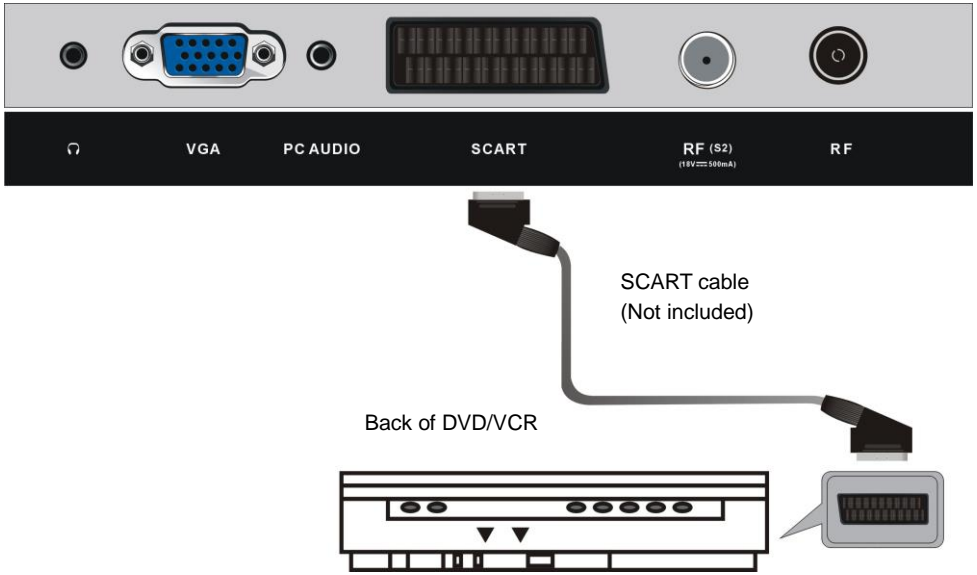

## AV (COMPOSITE VIDEO) CONNECTION

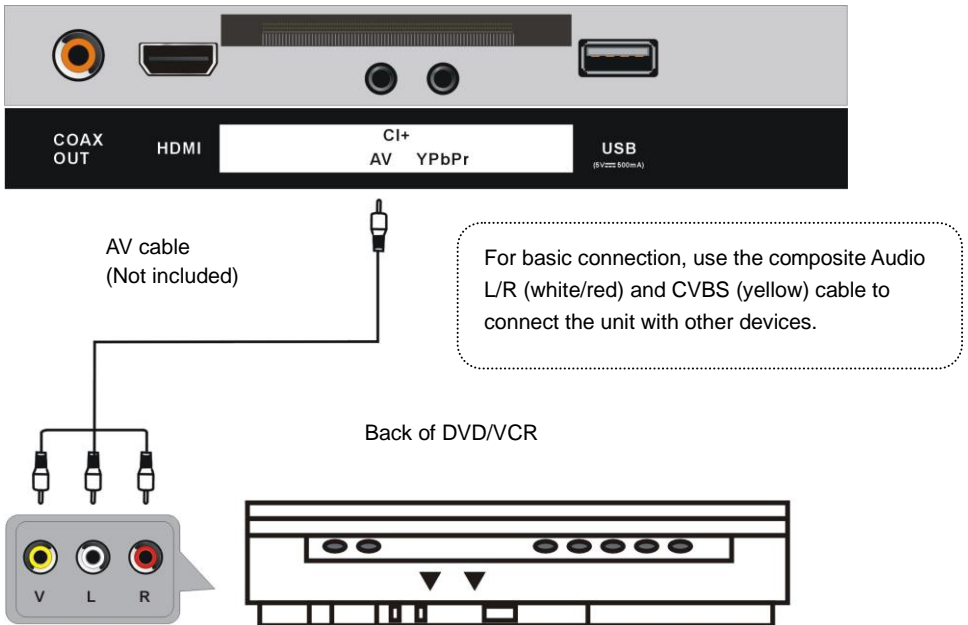

## YPbPr CONNECTION

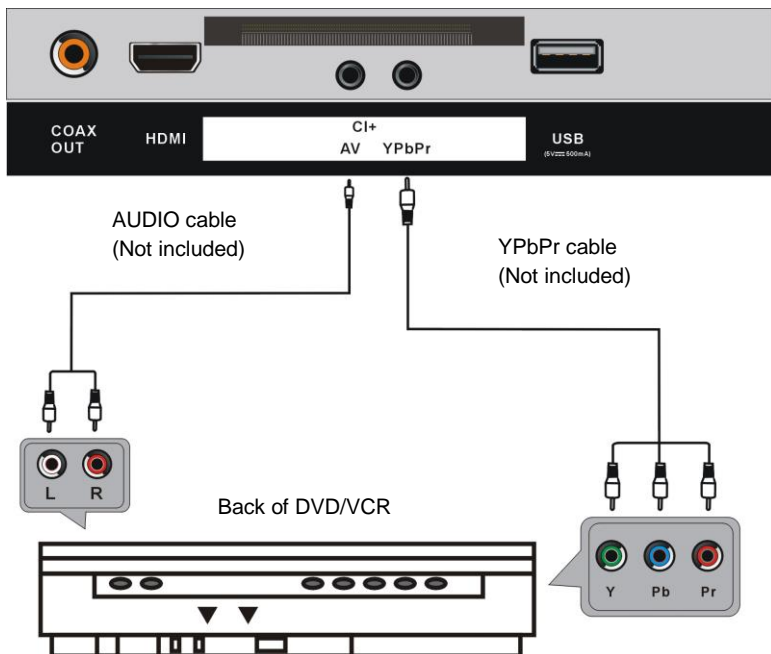

## COAXIAL CONNECTION

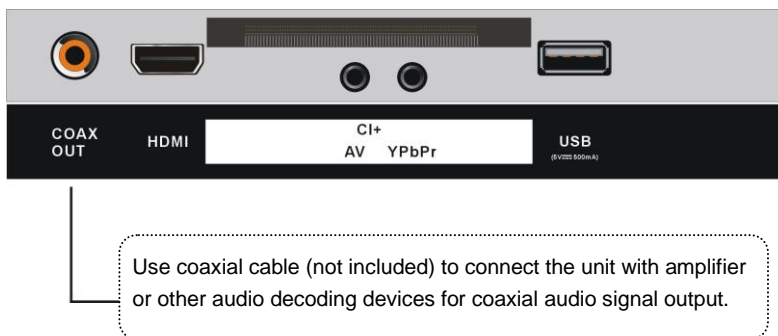

## USB CONNECTION

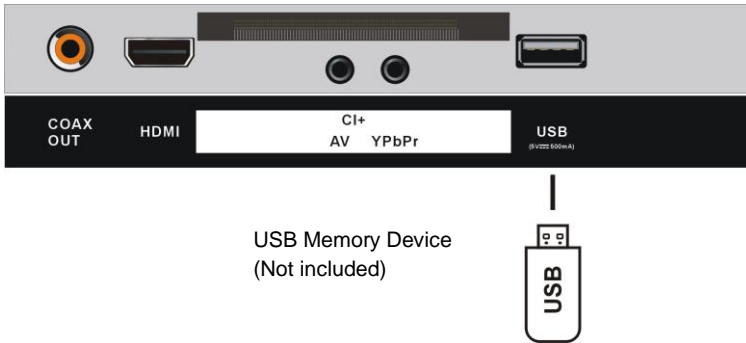

## INSERT A CI CARD (CI+ or standard)

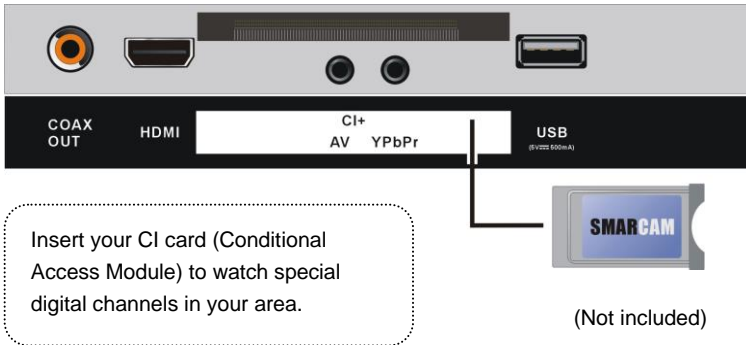

## EARPHONE CONNECTION

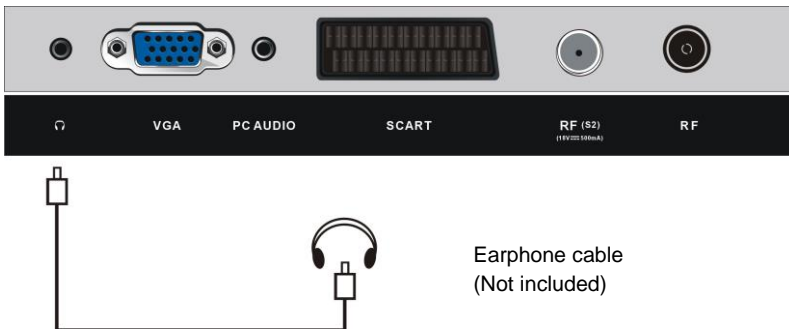



**MAKE SURE ALL THE EQUIPMENTS AND POWER CORD ARE CONNECTED PROPERLY AND THE UNIT IS SET IN CORRECT MODE BEFORE KINDS OF OPERATIONS.**

## **BASIC OPERATIONS**

- Press **POWER (STANDBY)** button on the unit or remote control to power **ON** the unit (indicator will glow blue); press it again to power **OFF** (standby mode) the unit (indicator will glow red).
- Press **SOURCE** button on the unit or remote control to switch the unit to **DTV** or **ATV** mode.

### **SELECT DESIRED PROGRAM**

1. Press **CH+** button to play next channel.
2. Press **CH-** button to play previous channel.
3. Press number buttons on remote control directly to select desired program.

**NOTE:** Press **-/--** button repeatedly to switch the digit.

### **VOLUME CONTROL**

- Press **VOL+** or **VOL-** to adjust the level of current volume.
- Available range: 0-100.

### **MUTE CONTROL**

- Press **MUTE** button to mute the sound, press it again to turn on the sound.

### **SOURCE SETTING**

- Press **SOURCE** button on the unit or remote control to display the sources list.
  - Press **UP** or **DOWN** navigation button to select desired input source, and then press **OK** button to confirm selection.
- Available options: Satellite, DTV, ATV, AV, SCART, YPbPr, HDMI, PC, USB.

### **MULTIAUDIO SETTING**

- Press **AUDIO** button on remote control and use navigation buttons to select desired audio language.
- NOTE:** To enable this function, make sure that the channel you are viewing supports multi-audio languages.

### **INFORMATION DISPLAY**

- Press **DISPLAY** button on remote control to display information of current program.

## EPG TV GUIDE (FOR DTV MODE ONLY)

- Press EPG button on remote control to display program guide.



7 Day TV GUIDE	
9:15 - 10:00 20 Jun 2015	
Presented by Ximo Rovira, the most spectacular and shocking videos of the TV. Tit: Total impact	
20 Jun 2015 09:25 <span style="float: right;">20 Jun 2015</span>	
800 The Hits	09:15 - 10:00 Hot Hits Non Stop <span style="float: right;">Now</span>
801 13 TV	10:00 - 11:40 Hit Chart - Most selected of today <span style="float: right;">Next</span>
802 Europe FM	11:40 - 15:20 Flash Box
803 Europe FM	15:20 - 19:55 Mashed Hits
804 Sports	19:55 - 22:30 The Hitlist - on demand
805 News	
806 Travel	

- Press UP/DOWN navigation button to select preferred program

- Press LEFT/RIGHT navigation button to switch between left column and right column.

**When a program is highlighted (cursor moved to Right column):**

- Press YELLOW button to display program guide of previous day.

- Press BLUE button to display program guide of next day.

## FAVORITE LIST

When viewing an available channel, press FAV button on remote control to enter Favorite List menu page.

- Press UP or DOWN navigation button to select preferred channel.

- Press OK button to confirm selection.

**Note:** To add a favorite channel, please refer to the operations of "Channel>Program Edit".



## QUICK SELECT

When viewing an available channel, press OK button on remote control to enter Channel List menu page.

- Press UP or DOWN navigation button to select preferred channel.
- Press LEFT/RIGHT navigation button to select a channel group.
- Press OK button to confirm selection.



## TELETEXT

- Press TEXT button on remote control to display the available teletext information and press it again to exit the teletext.

## TV/RADIO (FOR DTV MODE ONLY)

- Press TV/RADIO button on remote control to switch the unit between TV and radio mode.(DTV only)

## SUBTITLE

- Press SUBTITLE button on remote control repeatedly to select desired subtitle.

**NOTE:** To enable this function, make sure that the channel you are viewing supports multi-subtitle.

## MEDIA PLAYBACK(USB INPUT)

- Insert a USB memory device into USB slot before following operations.
- Press SOURCE button on the unit or remote control to switch the unit to USB mode or press MEDIA button on remote control.
- Press UP/DOWN/LEFT/RIGHT navigation button to select the file, press OK button to confirm the selection then press PLAY to start the selected file. Repeat the procedure to select/unselect new files.
- Press EXIT button to return to previous menu page.

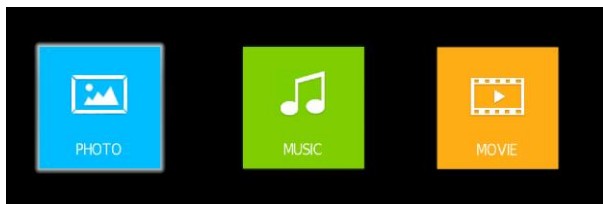

## 1. PHOTO

- Press LEFT/RIGHT navigation button to select Photo in the main menu and press OK button to enter it.
- Use navigation buttons to select desired folder or file.
- When selecting files, press RED button to enter submenu and you can delete a file accordingly.
- Use navigation buttons to select a file and press OK button to add to play list.
- Press ►|| button to start playback.
- Press DISPLAY button to call out the tool bar. Use navigation buttons to select desired option and press OK to confirm it.



- Press EXIT button to dismiss the tool bar.

## 2. MUSIC

- Press LEFT/RIGHT navigation button to select Music in the main menu and press OK button to enter it.
- Use navigation buttons to select desired folder or file.
- When selecting files, press RED button to enter submenu and you can delete a file accordingly.
- Use navigation buttons to select a file and press OK button to add to play list.
- Press ►|| button to start playback.

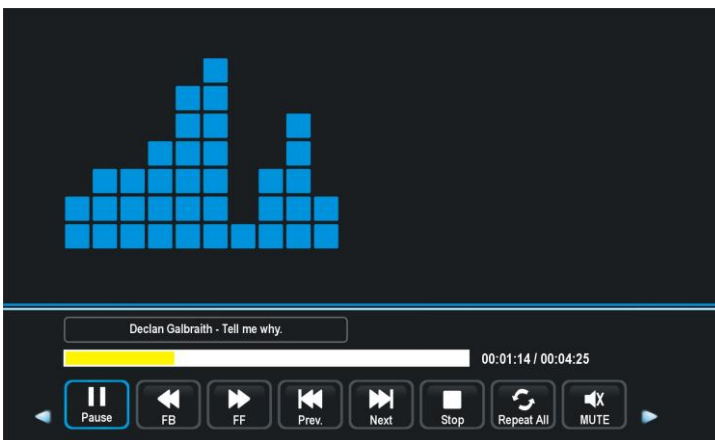

- Use navigation buttons to select desired option and press OK to confirm it.
- Press EXIT button to return.

### 3. MOVIE

- Press LEFT/RIGHT navigation button to select Movie in the main menu and press OK button to enter it.
- Use navigation buttons to select desired folder or file.
- When selecting files, press RED button to enter submenu and you can delete a file accordingly.
- Use navigation buttons to select a file and press OK button to add to play list.
- Press ►|| button to start playback.
- Press DISPLAY button to call out the tool bar. Use navigation buttons to select desired option and press OK to confirm it.

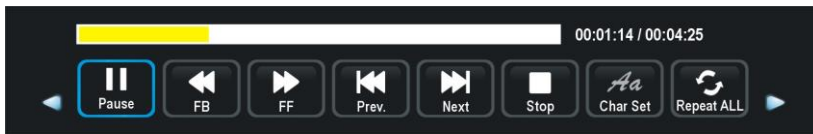

- Press EXIT button to return.

# MAIN MENU

- The unit contains different setting menus. Once the initial programming is entered, it will be remained in the memory until change, and the unit can always be operated under the same conditions.
- The settings will be remained in the memory until the settings are changed, even after setting the player to standby mode.

## **Common procedure for initial settings**

- Press MENU button on the unit or remote control to display the main menu.
- Press UP/DOWN/LEFT/RIGHT navigation buttons to move the cursor.
- Press OK or RIGHT navigation button to enter submenu.
- Press UP and DOWN buttons to select the option to adjust
- Press MENU button to save current setting and return to previous menu page.
- Press EXIT button to exit menu page.

## **First Time Installation**

- Connect to power source and turn on this TV, then below setup page will display on the screen.
- Press UP/DOWN navigation button to move the cursor.
- Press LEFT/RIGHT navigation button to select an option.

**Language:** select the on-screen menu language.

**Country:** select your country.

**Energy Mode:** select Home or Store mode.

## **Tuning Setup**

- If above selections are finished, press OK button to call out Tuning Setup.
- Select preferred Tune Type and Digital Type using navigation buttons and press OK button to start auto tuning.

**Note:** Digital Type is adjustable only under DVB-C mode.

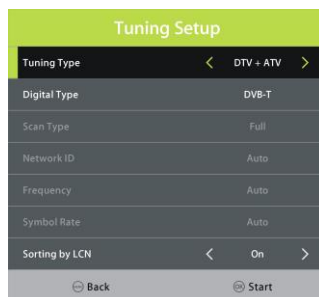
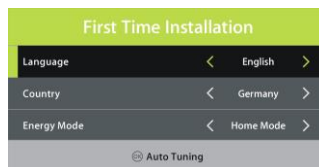

# DTV MODE

- Press the SOURCE button on the unit or remote control to select DTV input source.

## 1. CHANNEL



### 1.1 TV menu

- Press OK or RIGHT navigation button to enter it.
- Use navigation buttons to select DVB-T or DVB-C.

### 1.2 Auto Tuning

- Press OK or RIGHT navigation button to enter it.
- Use navigation buttons to set the Country, Tune Type and Sorting by LCN.

**Note:** Scan type and other items are adjustable only when "Antenna" is DVB-C.

- Then press OK to start program tuning.

### 1.3 ATV Manual Tuning

- Press OK or RIGHT navigation button to enter it.

**Current CH:** select current channel.

**Color System:** select available color system.

**Sound System:** select available sound system.

**Fine Tune:** fine tune the frequency.

**AFC:** turn on/off Automatic Frequency Control.

**Search:** search available programs.



## When “Antenna” is DVB-T:

### 1.4 DTV Manual Tuning

- Press OK or RIGHT navigation button to enter it.
- Use LEFT/RIGHT navigation button to select the channel. Then press OK button to start searching.

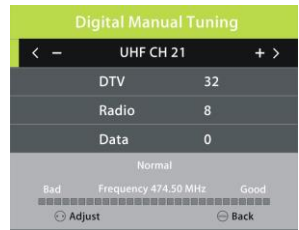

## When “Antenna” is DVB-C:

### 1.4 CADTV Manual Tuning

- Press OK or RIGHT navigation button to enter it.
- Use navigation buttons to adjust the Frequency, Symbol and QAM Type. Then press OK button to start searching.

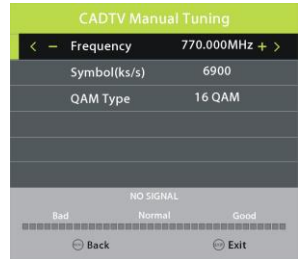

### 1.5 Program Edit

- Press OK or RIGHT navigation button to select the menu.
- Press UP/DOWN navigation button to highlight desired channel.
- Press RED button on remote control to delete highlighted channel.
- Press YELLOW button on remote control to enter MOVE mode. Then use UP/DOWN navigation button to select preferred position and press YELLOW button again to move it.
- Press BLUE button on remote control to skip highlighted channel.
- Press FAV button to set current channel as a favorite channel, and press FAV button again to set it as a normal channel.



### 1.6 Signal information (works under available TV signals)

This item is used to display signal details, for example: channel number and strength.

### 1.7 CI information (works under available TV signals)

When an available CAM (Conditional Access Module) card is connected to the CI slot, users can view related information or manage the CAM card.



## 2. PICTURE



### 2.1 Picture Mode

- Press UP/DOWN/LEFT/RIGHT navigation buttons to select an option.

**Picture Mode:** available options: Standard, Mild, Personal, Dynamic.

**Contrast / Brightness / Color / Tint / Sharpness:** adjustable value: 0-100.

**NOTE:** Contrast, Brightness, Color and Sharpness are adjustable only when Picture Mode is "User". Tint is adjustable only for NTSC system.

### 2.2 Color Temperature

This item is used to adjust the optimum color temperature for suitable viewing.

Available options: Normal, Warm, Cold.

### 2.3 Noise Reduction

Available options: Off, Low, Medium, High

Note: when the TV signal does not have noises we advise to keep this function off.

### 2.4 SCREEN (for PC/VGA mode only)

### 2.5 Dynamic CR

Turn on/off dynamic contrast ratio.

## 3. SOUND



### 3.1 Sound Mode

- Press UP/DOWN/LEFT/RIGHT navigation buttons to select an option.

**Sound Mode:** available options: Standard, Music, Movie, Sports, Personal.

**Treble / Bass:** adjustable value: 0-100.

**NOTE:** Treble and Bass are adjustable only when Sound Mode is “User”.

### 3.2 Balance

This item is used to adjust the audio output between left and right speaker from -50 to 50.

### 3.3 Auto Volume

This item is used to set Auto Volume ON or OFF.

### 3.4 Surround Sound

This item is used to select desired mode of Surround sound.

### 3.5 S/PDIF Mode

Available options: Auto, PCM, Off.

### 3.6 AD Switch

This item is used to turn on/off Audio Description function. For Visually Impaired users, this function can help to know a certain scene or action through the narration, instead of see it.

**NOTE:** AD Switch function works only when you are viewing programs that contain related narration information.

## 4. TIME

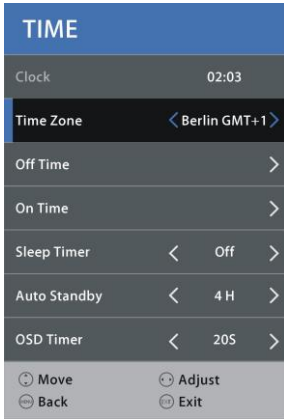

### 4.1 Clock

It displays current system time when an available channel was saved.

### 4.2 Time Zone

This item is used to select desired time zone.

### 4.3 Off Time

**Off Time:** available options: Off / Once / Every Day / Mon~Fri / Mon~Sat / Sat~Sun / Sun.

**Hour / Minute:** use navigation buttons to adjust the Hour / Minute when Off Time is not "Off".

### 4.4 On Time

**On Time:** available options: Off / Once / Every Day / Mon~Fri / Mon~Sat / Sat~Sun / Sun.

**Hour / Minute / Source / Channel / Volume:** use navigation buttons to adjust these items when Off Time is not "Off".

### 4.5 Sleep Timer

This item is used to set the automatic sleep time when no signals.

Available options: Off, 10min, 20min, 30min, 60min, 90min, 120min, 180min, 240min

### 4.6 Auto Standby

This item is used to select desired Auto Sleep (standby) duration when no operations were done through the remote control.

Available options: Off, 3/4/5 hours.

## 4.7 OSD Timer

This item is used to select desired OSD menu duration.

Available options: Off, 5/10/15/20/25/30/35 seconds.

## 5. LOCK

- Press RIGHT navigation button and input the factory default password “0000” using number buttons on remote control.

- Press UP/DOWN navigation button to select preferred item.

**NOTE:** If you forget the password, please use the universal password “8899”.

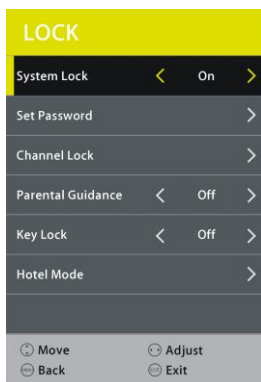

### 5.1 System Lock

This item is used to turn on/off Lock System.

### 5.2 Set Password

- Input the old password using number buttons on remote control and then input your private password twice to finish it.

### 5.3 Channel Lock

- Press OK or RIGHT navigation button to enter it.

- Press UP/DOWN navigation button to select the channel which you want to lock.

- Press GREEN button repeatedly to lock/unlock the highlighted channel.

### 5.4 Parental Guidance

This item is used to select desired program rating.

Available options: Off, 4-18.

### 5.5 Key Lock

This item is used to lock/unlock TV buttons.

Available options: On, Off.

## 5.6 Hotel Mode

- Press RIGHT navigation button to enter it.

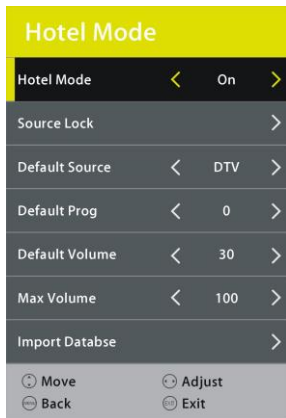

- Press UP/DOWN navigation button to move the cursor.
- Press LEFT/RIGHT navigation button to select an option.

**Hotel Mode:** turn on/off Hotel Mode.

**Source Lock:** turn on/off the lock of available sources.

**Default Source:** set the default source.

**Default Prog:** set the default digital program.

**Default Volume:** set the default volume level.

**Max Volume:** set the maximum volume level.

**Export DataBase:** export database to USB device.

**Import DataBase:** import database from USB device.

**Clear Lock:** Clear above settings.

## 6. SETUP



### 6.1 Language

This item is used to select desired on-screen display language.

### 6.2 TT Language

This item is used to select desired teletext language.

### 6.3 Audio Language

- Press RIGHT navigation button to enter it.
- Then you can select desired primary audio language and secondary audio Language.

### 6.4 Subtitle Language

- Press RIGHT navigation button to enter it.
- Then you can select desired primary subtitle language and secondary subtitle Language.

### 6.5 Hearing Impaired

This item is used to turn on/off Hearing Impaired function. For Hearing Impaired users, this function can assist help to know a certain scene or action through the caption, instead of hearing it.

**NOTE:** Hearing Impaired function works only when you are viewing programs that contain related caption information.

### 6.6 Aspect Ratio

This item is used to adjust the video size.

Available options: Auto, 4:3, 16:9, Zoom1, Zoom2.

**NOTE:** The available video size may be different for different input source.

## 6.7 Blue Screen

This item is used to turn on/off Blue Screen. The screen background will turn blue at very weak or no signal condition, if Blue Screen is ON.

## 6.8 First Time Installation

This item is used to recall the First Time installation menu.

## 6.9 Energy Mode

This item is used to select Home or Store mode.

## 6.10 Reset

This item is used to recall factory default settings.

## 6.11 Software Update (USB)

This item is used to update software through the USB memory device.

## 6.12 HDMI CEC (Consumer Electronic Control)

- Press RIGHT navigation button to enter it.

### To use HDMI CEC function:

- Make sure the HDMI device (Amplifier, etc.) is connected correctly.
- Press SOURCE button on the unit or remote control to select HDMI input source.

**HDMI CEC:** turn on/off HDMI CEC.

**HDMI ARC:** turn on/off ARC function.

**Auto Power:** turn on/off Auto Power function.

**Device Menu:** display the setup menu of other device connected.



## ATV AND OTHER MODES

- Press SOURCE button on the unit or remote control to select desired input source.
- For these modes, please refer to the menu operations of DTV mode.

# SATELLITE MODE

## Tips:

- **Connect your Satellite antenna to the LBN terminal first to receive satellite signals.**
- **Press SOURCE button on remote control to select “Satellite”.**

## 1. Auto Tuning

- Press MENU button to call out the main menu.
- Highlight “TV” using navigation buttons and press OK to enter it.
- Then highlight “Auto Tuning” and press OK to enter it.

**Country:** select your country.

**Satellite:** select an available satellite.

**Scan Mode:** select your scan mode.

**Channel Type:** select a channel type.

**Service Type:** select a service type.



## 2. Dish Setup

- Press MENU button to call out the main menu.
- Highlight “TV” using navigation buttons and press OK to enter it.
- Then highlight “Dish Setup” and press OK to enter it.
- Press LEFT/RIGHT navigation button to highlight Left, Middle or Right column.
- Use the options on screen to modify the settings.
- Press EXIT button to return.

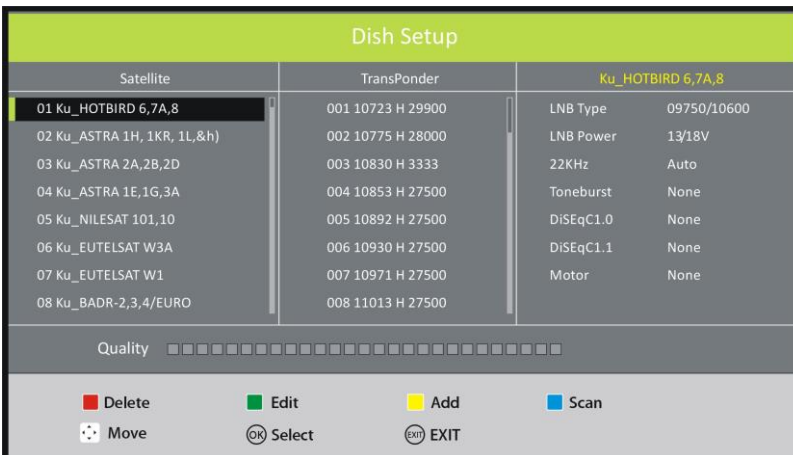



## **PC MODE**

- Connect a personal computer to this unit.
- Power on your computer and this unit.
- Press SOURCE button on the unit or remote control to select PC-RGB (VGA) input source.
- Press MENU button to display the main menu and select "PICTURE" using LEFT/RIGHT navigation button.
- Use UP/DOWN navigation button to highlight "SCREEN" and press OK or RIGHT navigation button to enter it.
  
- Press UP/DOWN navigation button to select preferred item.
- Press OK or RIGHT navigation button to enter submenu. Press LEFT/RIGHT navigation button to adjust the value.

### **1. Auto Adjust**

This item is used to adjust the PC screen automatically.

### **2. H-Offset**

This item is used to adjust the value of horizontal position.

### **3. V-Offset**

This item is used to adjust the value of vertical position.

### **4. Size**

This item is used to adjust the picture apply to the TV.

### **5. Phase**

This item is used to adjust the signals transfer speed.

**NOTE:** For other menu operations in PC-RGB (VGA) mode, please refer to the menu operations of DTV mode.



## MAINTENANCE

- Be sure to press STANDBY button to set the player to the standby mode and disconnect the power plug before maintaining the player.
- Wipe the player with a dry, soft cloth.
- If the surface is extremely dirty, wipe clean with a cloth which has been dipped in a weak soap-water solution and wrung out thoroughly, and then wipe again with a dry cloth.
- **Never** use alcohol, benzene, thinner, cleaning fluid or other chemicals. And do not use compressed air to remove dust.

## WALL MOUNTING

- Contact a professional for assistance when wall mounting your TV. We are not responsible for any damage to the product or injury to yourself, if you mount the TV on your own.
- Do not wall mount the TV while TV is turned on. It may cause personal injury due to electric shock.
- Use standard M4\*8mm screws (4 pieces, not included) to mount this TV.

Back of your TV

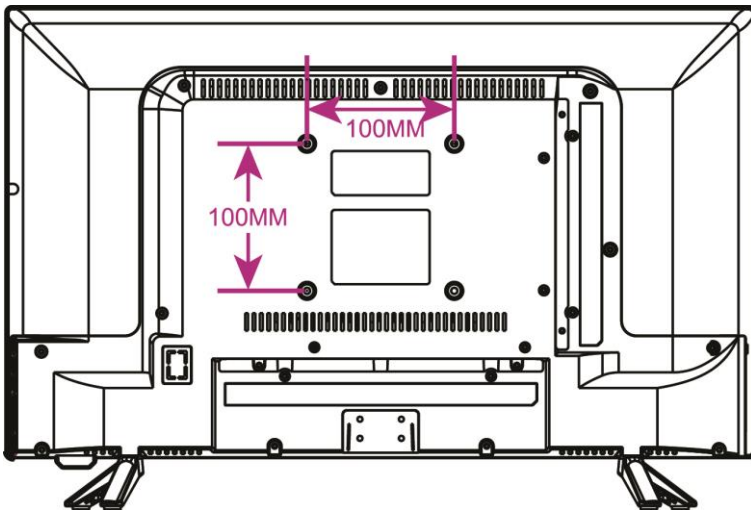

# STAND INSTALLATION

Your TV is packaged with the Stand and the Cabinet separated. Before enjoying this TV, please carry out the Stand Installation according to the instructions below.

## Step 1

Place the TV faced down on a soft cloth or cushion to prevent the panel from being damaged.

## Step 2

Align the Stands with TV bottom in the correct position as per picture (2).

## Step 3

Tighten the included screws with a screw driver.

## NOTES:

- 1) Unplug the power plug first when installing or removing the TV Stand.
- 2) To avoid any damage to this TV, contact one or more partner for assistance when installing or removing the TV stand.

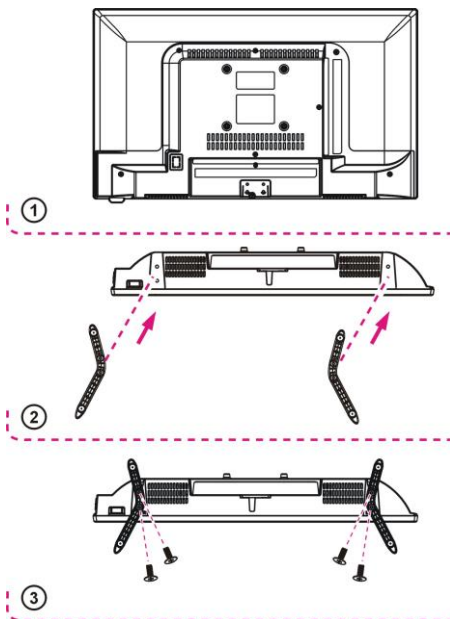

# SPECIFICATIONS

<b>Display Device</b>	22 inch LED FULL HD TV
<b>Resolution</b>	1920×1080
<b>Pixel Pitch</b>	0.24795(H)×0.24795(V) mm
<b>Luminance</b>	180 cd/m <sup>2</sup> (+/-10%)
<b>Contrast Ratio</b>	1000:1
<b>Aspect Ratio</b>	16:9
<b>Response Time</b>	14 ms
<b>Viewing Angle</b>	178(H)/178(V)
<b>Visible Range</b>	476.064(H)×267.786(V) mm

## Tuner:

Analogue tuner PAL (BG/DK/I); SECAM (BG/DK/L)

DVBT/T2 HD tuner

DVB-S2 HD tuner

Automatic channel search

LCN function (logical channel numbering)

EPG (electronic program guide)

Hotel function

## USB input

### USB:

Supported formats: AVI / MP4 / MKV / MPG / TS / VOB

Video: MPEG1, MPEG2, MPEG4/Xvid, VC1, H264, HEVC (H.265) fine at 1080p / 30fps

Photo: JPEG, BMP

Music: MP3, WMA

Although the unit has been tested with most commercially available USB devices it is impossible to establish a universal compatibility level, due to continuous technical / technological updates.

## Inputs

CAM CI+ (conditional Access Module) not supplied

Input: HDMI, VGA, AV, Component Y/Pb/Pr, SCART

PC audio input (stereo 3,5 mm)

Antenna 75 ohms input (DTV/ATV)

Satellite antenna LBN input (DVB-S2)

Headphones/earphones jack 3,5mm

Support bases included

## Video Input

PC-RGB (VGA)	Up to 1920 × 1080 @ 60Hz
CVBS	Color System: PAL/NTSC/SECAM
	Video Level: 1Vp-p @ 75ohm
YPbPr	480i, 480p, 576i, 576p, 720p, 1080i, 1080p
HDMI	480i, 480p, 576i, 576p, 720p, 1080i, 1080p
SCART	CVBS & RGB

## Double power supply system: AC 100 / 240V (50 / 60Hz) - DC 12V

Operation temperature -5° to 35°

Unit dimensions: 50.9 (L) x 30.7 (H) x 7.8 (D) cm

Dimensions with stand: 50.9(L) x 34,2 (H) x 16.5 (D) cm

Weight with stand: Approx. 2.3 kg

## GENERAL TROUBLESHOOTING

Check the following points before assuming malfunctions of this unit:

Symptom	Remedy
No power.	Insert the power plug securely into the power outlet.
No picture.	Ensure that the equipment is connected properly.
<ul style="list-style-type: none"> <li>● No sound.</li> <li>● Distorted sound.</li> </ul>	<ul style="list-style-type: none"> <li>● Ensure that the equipment is connected properly.</li> <li>● Ensure that the input setting for the TV and stereo system are correct.</li> <li>● Adjust the master volume to a suitable volume by pressing VOL+/VOL- button.</li> </ul>
No operations can be performed with the remote control unit.	<ul style="list-style-type: none"> <li>● Check the batteries are installed with the correct polarities.</li> <li>● The batteries are exhausted: Replace them with new ones.</li> <li>● Point remote control at the remote control sensor and operate it again.</li> <li>● Operate the remote control unit at a distance of no more than 6m from the remote control sensor.</li> <li>● Remove the obstacles between the remote control and remote control sensor.</li> </ul>
No key operation (by the main unit and/or the remote control unit) is effective.	Disconnect the power plug and then reconnect it. (The TV may not be operating properly due to lightning, static electricity or some other factors.)
Symptom(TV)	Remedy
No or poor picture.	<ul style="list-style-type: none"> <li>● Adjust antenna or use an external antenna.</li> <li>● Relocate the unit near a window (if inside a building).</li> <li>● Move units away from this product that causes interference.</li> <li>● Do Auto Tuning again.</li> <li>● reset to factory settings.</li> </ul>
No sound or poor sound.	<ul style="list-style-type: none"> <li>● Check the audio settings.</li> <li>● Press MUTE button on remote control to cancel mute function.</li> <li>● Unplug the headphone.</li> </ul>
Noise or other interface.	Electronic equipment near the unit is causing interface. Relocate the unit or move the equipment.

## INFORMATION TO USERS OF DOMESTIC EQUIPMENT



***Pursuant to Art. 25, Paragraph 1 of the Legislative Act N. 49 14th March 2014, "Implement of the Directives 2011/65 / EU and 2012/19 / EU concerning the reduction of the use of hazardous substances in electrical and electronic equipment, as well as waste disposal".***

The crossed bin symbol on the appliance or on its packaging indicates that the product at the end of its useful life must be collected separately from other waste. The user must, therefore, dispose the equipment at the end of its life to the appropriate electronic and electro technical waste centers, or return it to the retailer at the time of purchase of a new type of equivalent equipment, one by one.

Appropriate separate disposal for the subsequent start-up of the disused equipment for recycling, treatment and compatible environmental disposal helps to avoid possible negative effects on the environment and health and favours the re-use and / or recycling of the materials it is composed the equipment.

The illegal disposal of the product by the user involves the application of the penalties referred to in current laws.

Any rechargeable batteries or rechargeable batteries contained in the device must be disposed separately in the appropriate expired batteries bins.

### **Battery disposal**



Disposal of expired batteries must take place at the appropriate recycling centers or according to local authority. Batteries in compliance with the 2013/56 / EC directive.

# MAJESTIC

TV 21.5" TFT LED

MOD. TVD 222/S2 LED

ALIMENTAZIONE: AC 100-240V~50/60Hz 36W DC12V

CONSUMO IN STANDBY: MAX. 0.5W

USB: 5V == 500mA



NEW MAJESTIC S.p.A.

Via Rossi Martini, 41

26013 CREMA (CR)

ITALY

MADE IN EU



= Class II, double insulation



= WEEE Logo (Waste of electrical and electronic equipments)



= Battery disposal



MADE IN EU

## MAJESTIC

NEW MAJESTIC S.P.A.

Via Rossi Martini 41

26013 CREMA (CR)