

MAJESTIC

24" WIDESCREEN LED TV

MODEL NO.: ST24VD

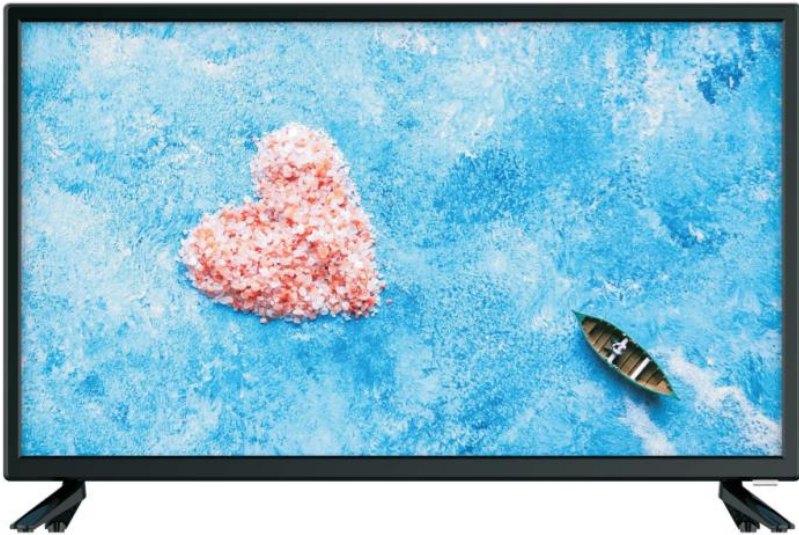

USER MANUAL

CE



New Majestic S.p.A. Via Rossi Martini, 41, 26013 Crema (CR) – Italy

www.newmajestic.com

MADE IN EU

Please read this manual carefully before using,
and keep it for future reference.

IMPORTANT INSTRUCTIONS

SAFETY INSTRUCTIONS



WARNING – TO REDUCE THE RISK OF FIRE, ELECTRIC SHOCK, OR SERIOUS PERSONAL INJURY:

- This product shall not be exposed to dripping or splashing and that no objects filled with liquids, such as vases, shall be placed on the apparatus.
- Situate this product away from heat sources such as radiators, heat registers, stoves, or other appliances (including amplifiers) that produce heat.
- Clean the product only as recommended by the manufacturer (see “Maintenance” section for details). Unplug the power cord from the wall outlet before cleaning,
- Unplug the power cord from the wall outlet when left unused for an extended period.
- Prevent objects/liquids from falling or spilled on the product.
- Operate the product only with the supplied power cord. Route power cords so they are not likely to be walked on or pinched by items placed upon or against them, paying particular attention to plugs, convenience receptacles, and the point where they exit from the product.
- Where the MAINS plug or an appliance coupler is used as the disconnect device, the disconnect device shall remain readily operable.
- Do not operate this product under the following conditions.
 - When the power-supply cord or plug is damaged.
 - If liquid has been spilled into or objects have fallen into the product.
 - If the product has been exposed to rain or water.
 - If the product does not operate when used according to the operating instructions.
 - If the product has been dropped or damaged in any way.
- Do not attempt to service the product; take it to the electronics repair shop of your choice for any servicing or repair.
- Do not overload wall outlets, extension cords, or integral convenience receptacles.
- Connect this product to the power outlet which has protective earth connection.



CAUTION- TO REDUCE THE RISK OR PERSONAL INJURY OR PRODUCT/PROPERTY DAMAGE:

- This product is intended solely for non-commercial, non-industrial, personal use as a television. Do not use this product for any other purpose.
- Do not subject the product to violent shocks, extreme temperatures, or lengthy periods under direct sunlight.
- Keep the product away from magnetic objects, motors, and transformers.
- Do not use outdoors in inclement weather.
- Do not use the TV while driving; this is dangerous and is illegal in some areas.

BATTERY HANDLING AND USAGE:

- Keep batteries away from children and pets. Only adults should handle batteries.
- Never throw batteries into a fire or expose them to fire or other heat sources.
- Follow the battery safety and usage instructions provided by the manufacturer.

ACCESSORIES

User Manual.....1
 Remote Control.....1
 Car Adaptor.....1

All the pictures in this manual are just for your reference, appearance and display should subject to the final product.

TABLE OF CONTENTS

GETTING STARTED

IMPORTANT INSTRUCTIONS.....	1-2
ACCESSORIES.....	2
FEATURES.....	4
GENERAL PARTS.....	5-6
REMOTE CONTROL.....	7-8
REMOTE CONTROL PREPARATION.....	9
BASIC CONNECTION.....	10-13
BASIC OPERATIONS.....	14
LIVE TV.....	15-17
CONNECTION.....	18-20
MULTI-SCREE.....	21-22
SMART FUNCTION.....	23-25
PICTURE AND SOUND.....	26-27
SYSTEM AND SUPPORT.....	28-30
HOTEL MODE.....	30

FOR REFERENCE

MAINTENANCE.....	31
WALL MOUNTING.....	31
STAND INSTALLATION.....	32
SPECIFICATIONS.....	33
TROUBLESHOOTING.....	34

FEATURES

24 " FULL HD LED Display

With Parental Control

Support Auto TV Scanning

Analogue tuner and DVB-T

DVB-S tuner

Support EPG (Electric Program Guide) Function

Support TELETEXT (Europe) Function

Support USB Multimedia Playback

Support Multi-languages On Screen Display

Support Full Function Remote Control

Support HDMI x3, CVBS & Audio L.R, LAN Input

CI+ (high definition contents playback supported)

Support EARPHONE and OPTICAL Output

With Detachable Stand Holder

With External Antenna Jack (DVB-T/DVB-S)

With Built-in Speakers

GENERAL PARTS

MAIN UNIT

Front View

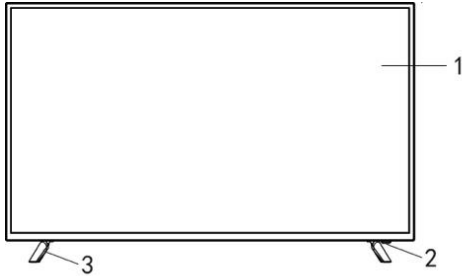

Back View

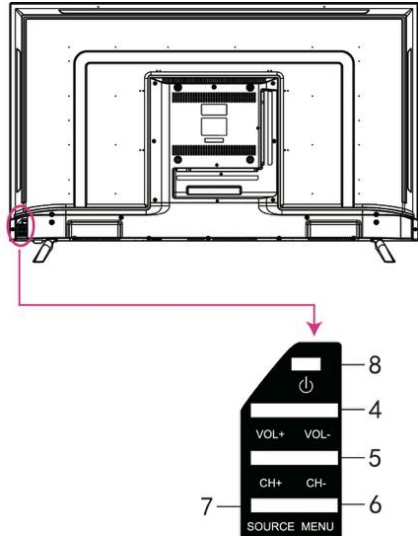

1. LED display screen
2. Remote control sensor. In standby mode the indicator light will display red color; when switching on the unit the indicator light will display blue color.
3. Stand holder
4. SOURCE button- To select the input source.
5. MENU button- To enter menu setting page.
6. CH +/- button- To select next/previous channel or move up/down.
7. VOL +/- button- To increase/decrease the volume level or move left/right.
8. STANDBY button- To turn ON/OFF the TV.

GENERAL PARTS

Back View

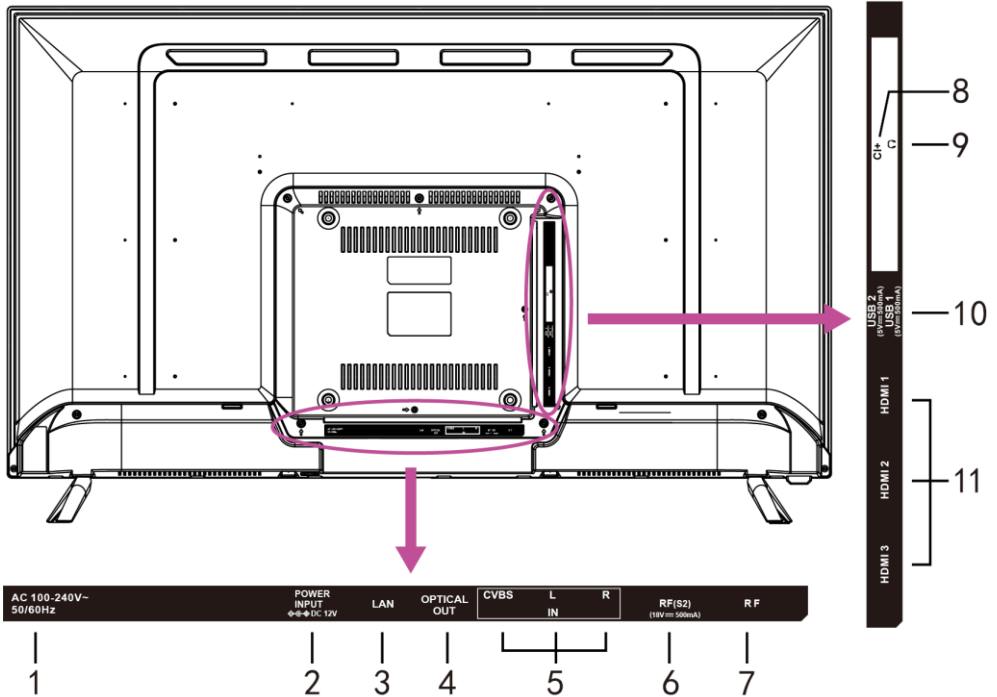

1. AC Power input
2. DC Power input (12V)
3. LAN (Local Area Network) input terminal
4. OPTICAL output terminal
5. CVBS and Audio L/R input terminal
6. RF input terminal- To connect the external Satellite TV Antenna (DVB-S2)
7. RF input terminal- To connect the external TV antenna (DVB-T/DVB-T2/DVB-C)
8. CI+ input terminal
9. EARPHONE output terminal
10. USB 1/2 input terminal
11. HDMI 1/2/3 input terminal

REMOTE CONTROL

1 **STANDBY(POWER)**

Set the unit in standby mode; press it again to switch it on.

2 **INPUT**

Select desired input source.

3 **Number buttons (0-9)**

Input the number information, such as channel number and so on.

4 **GUIDE**

Launch the Program Guide.

5 **CH.LIST**

Press to show channel list.

6 **4 Color**

Customized in different page.

7 **☰ (MENU)**

Call out the main menu or return to previous menu.

8 **▶||**

Press to operate start/pause playing; Move fast forward; Move fast backward.

9 **DIRECTION/OK**

Move up, down, left, right/Confirm.

10 **↶**

Return to the previous interface or menu.

11 **EXIT**

Exit the current interface or menu.

12 **🏠 (HOME)**

Press to enter home page.

13 **VOL +/-**

Increase/decrease the volume level.

14 **CH +/-**

Play the next/previous program.

15 **🔇 (MUTE)**

Mute the sound.

16 **SUBTITLE**

Select available subtitles.

17 **TEXT**

Turn on/off the Teletext.



18 INFO

Display the available program information.

19 

Set up APP shortcut key.

20 Free

Enter to the free video.

21 DEEZER

Enter to the deezer directly.

22 Content area

Six buttons for CSP Apps.



Note: The marks and positions of remote control may vary depending on the model.

REMOTE CONTROL PREPARATION

BATTERY INSTALLATION

Install the batteries as the following pictures. Be sure + and – terminals are positioned as indicated in the battery compartment (Fig1).

SERVICE LIFE OF BATTERIES

- The batteries normally last for one year although this depends on how often the remote control is used.
- If the remote control fails to work even when it is operated near the player, replace the batteries.
- Use two size AAA dry batteries.

NOTE:

- Do not drop, step on or otherwise impact the remote control. This may damage the parts or lead to malfunction.
- If the remote control is not going to be used for a long time, remove the batteries.

REMOTE CONTROL OPERATION

Point the remote control from no more than about 6m from the remote control sensor and within about 60° of the front of the player (Fig2).

NOTES:

- The operating distance may vary according to the brightness of the room.
- Do not point bright light at remote control sensor.
- Do not place objects between the remote control and the remote control sensor.
- Do not use this remote control while simultaneously operating the remote control of any other equipments.

Fig1

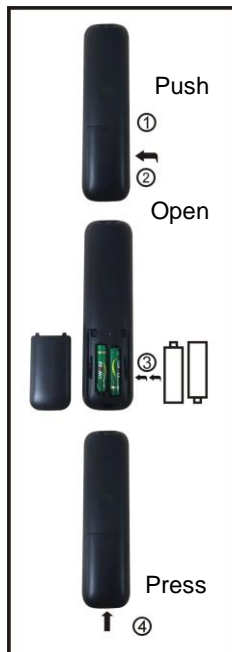
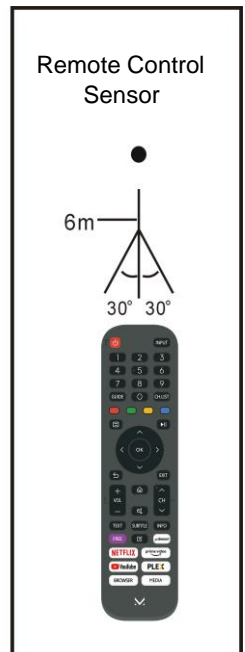

Fig2



BASIC CONNECTION

- Ensure all the cables are disconnected from the main unit before connecting to AC power source.
- Read through the instructions before connecting other equipments.

CONNECTING TO AC POWER SOURCE

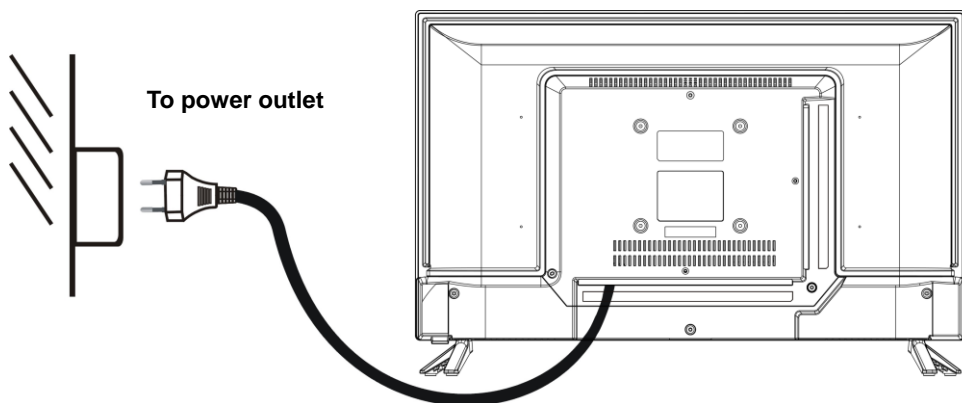

CONNECT EXTERNAL ANTENNA TO UNIT

Install external antenna into antenna jack for best picture.

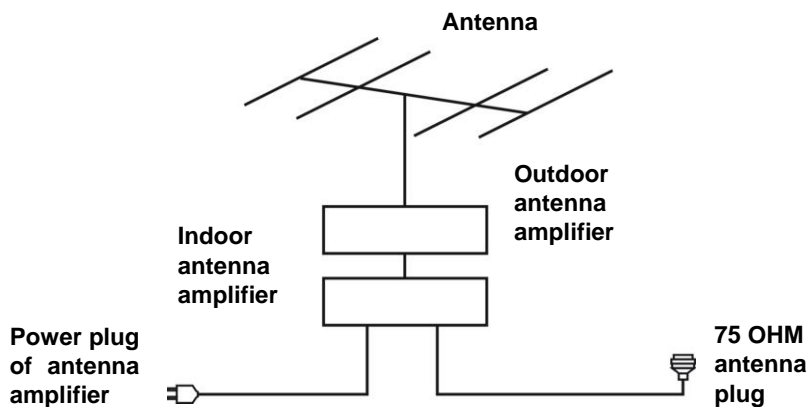

HDMI CONNECTION

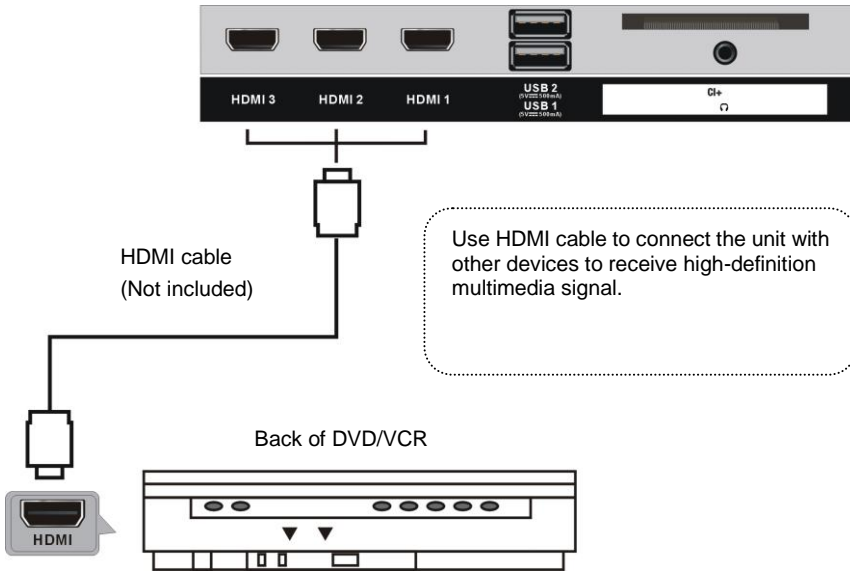

COMPOSITE AV (CVBS) CONNECTION

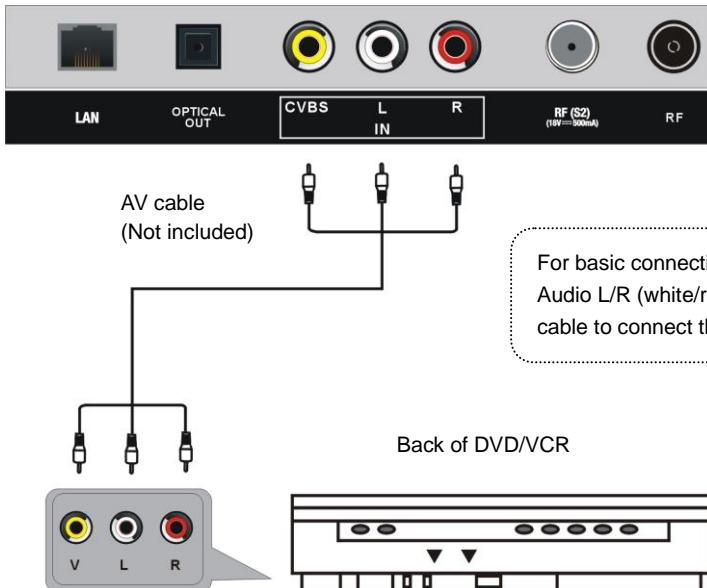

OPTICAL CONNECTION

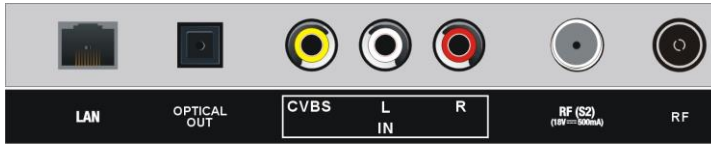

Use OPTICAL cable (not included) to connect the unit with amplifier or other audio decoding devices for coaxial audio signal output.

USB CONNECTION

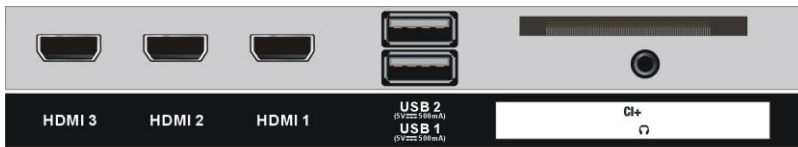

INSERT A CI CARD (CI+ or standard)

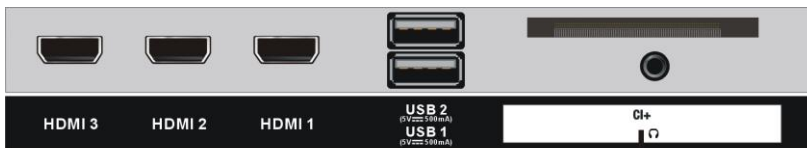

(Not included)

Insert your CI card (Conditional Access Module) to watch special digital channels in your area.



LAN (Local Area Network) Connection

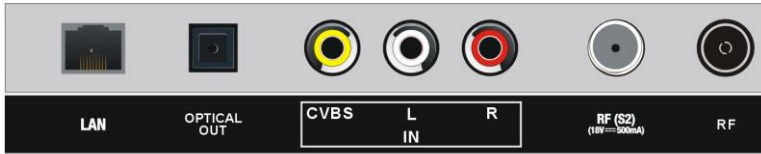

Use a LAN cable (not included) to connect this TV with available network.

EARPHONE CONNECTION

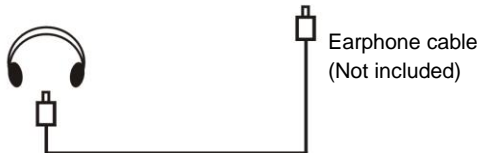
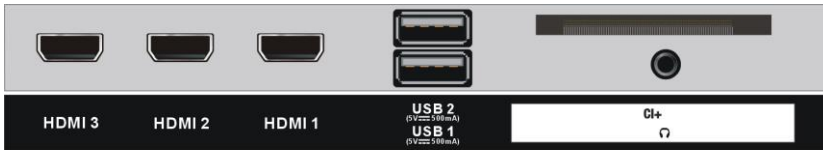

Earphone cable
(Not included)

MAKE SURE ALL THE EQUIPMENTS AND POWER CORD ARE CONNECTED PROPERLY AND THE UNIT IS SET IN CORRECT MODE BEFORE KINDS OF OPERATIONS.

BASIC OPERATIONS

*- Press **STANDBY** button on the unit or remote control to power **ON** the unit (indicator will glow blue); press it again to power **OFF** (standby mode) the unit (indicator will glow red).*

SELECT DESIRED PROGRAM

1. Press CH+ button to play next channel.
2. Press CH- button to play previous channel.
3. Press number buttons on remote control directly to select desired program.

VOLUME CONTROL

- Press VOL+ or VOL- to adjust the level of current volume.
Available range: 0-100.

MUTE CONTROL

- Press MUTE button to mute the sound, press it again to turn on the sound.

INPUT SETTING

- Press INPUT button on the remote control to display the sources list.
- Press UP or DOWN navigation button to select desired input source, and then press OK button to confirm selection.

MULTIAUDIO SETTING

- Press MENU button on remote control and use navigation buttons to select Audio Language, choose the desired audio language.

NOTE: To enable this function, make sure that the channel you are viewing supports multi-audio languages.

INFORMATION DISPLAY

- Press INFO button on remote control to display information of current program.

MEDIA PLAYBACK

- Press INPUT button on remote control to switch the unit to USB mode.
- Insert a USB memory device into USB slot before following operations.
- Press UP/DOWN/LEFT/RIGHT navigation button to move the cursor.
- Press BACK button to return to previous menu page.

LIVE TV

Channel Scan

Auto Channel Scan

 > **Settings** > **Channel** > **Auto Scan**

Note:

- Before you select Auto Channel Scan, you can press  > **Settings** > **Channel** > **Auto Scan**, press **OK** button into the submenu, select **Change Setup** and press **OK** button to select Satellite, Antenna or Cable.

Channel List

- Display the channel list
- In Live TV, press  button on the remote control to display the channel list menu.



Favorite

- Adding channels to your 'Favorites' list
- Press **ok** button to call out the channel list, the channel list appears on the right side of the screen.
- Press **Menu** > **ok** to select your favorite channel.
- Press **Left Arrow** and Choose Add to Favorite, select FAV1,FAV2,FAV3 or FAV4 and press OK to confirm your selection. A heart-shaped icon will appear next to your favorite channel.

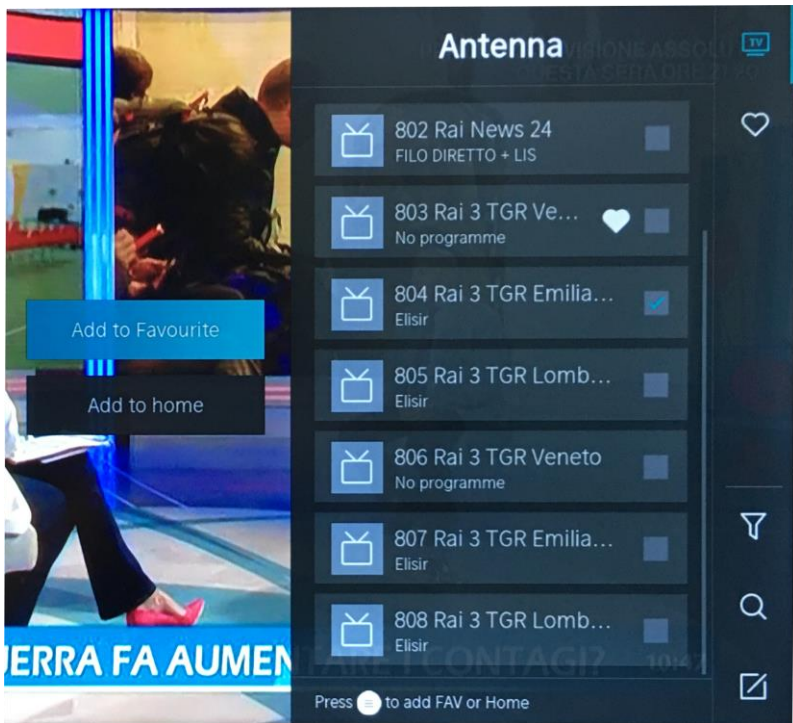

Viewing your 'Favorites' list

Press **ok** to call out the channel list, the channel list appears on the right side of the screen.

Press **Right Arrow** > Favorite > **Right Arrow**, press the Navigation button select FAV1,FAV2,FAV3 or FAV4

press OK and your favorite channel with a heart-shaped icon will appear on the favorite list.

Deleting channels from your 'Favorite' list

Press **OK** to call out the channel list, the channel list appears on the right side of the screen.

Press **➤** > Favorite, using the Navigation button to select **✎** (Edit) into the sub-menu, select the FAV channel that you want to delete.

Press **➤** to delete.

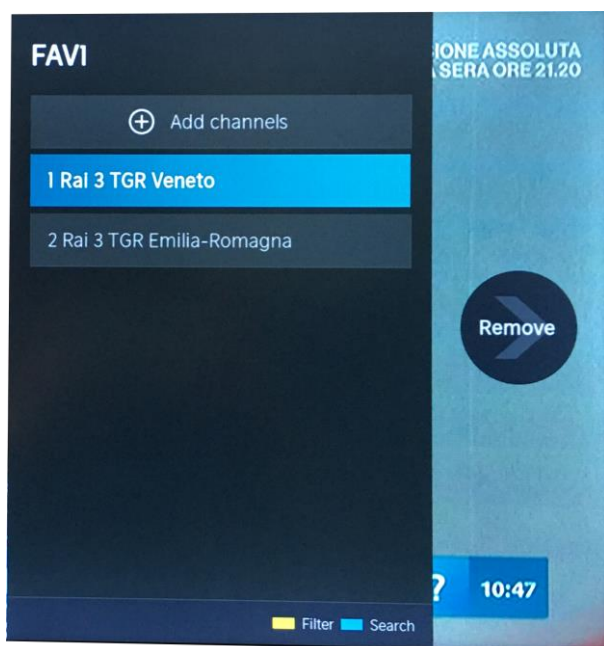

Note:

- These steps should be operated under TV inputs.
- Before you edit the fav lists, complete channel scan first.

CONNECTION

Wired LAN

Connecting to the Internet

 > Settings > Network > Network Configuration

You set the TV network by selecting Configuration and press the  button to enter the submenu.

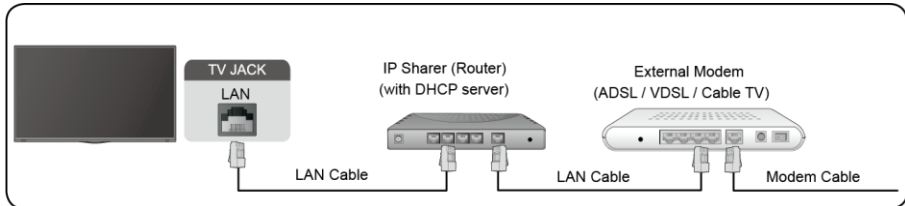

Automatically obtain an IP address

1. If you connect to the wired network, the TV will automatically obtain an IP address and connect to the network.
2. If the connection fails, disconnected message will display for the Ethernet status. Retry or enter the IP settings, and select Manual to input the information again.

Manually enter the IP address

1. Enter the IP settings to select Manual.
2. Enter the IP Address, Netmask, Gateway, DNS Server 1 and DNS Server 2 in the menu.

Note:

- This section is only for 4K models.
- You get access to the Internet through your TV.
- The default option of IP Settings Mode is DHCP.

Wireless

Connecting to the Internet

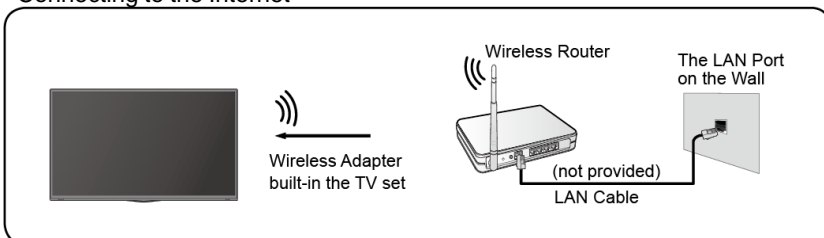

Note:

- You get access to the Internet through your TV.
- Connect to an available wireless network.
- Make sure that you have the wireless router's SSID and password before attempting to connect.

Connecting to a Wireless Network

 > **Settings** > **Network** > **Network Configuration**

You set the TV network by selecting Configuration and press the  button to enter the submenu.

- **Connection Type**
Choose a wireless network connection to access the Internet.
- **Refresh**
Refresh wireless network.
- **Advanced Settings**
Configure the advanced wireless network settings for the TV.
- **Add**
You can add wireless network.

Note:

- If no wireless router is found, select **Add** and enter the network name in the SSID.
- If no wireless router is found, select **Refresh**.

HDMI-CEC

You can use your TV remote to control the external devices that are connected to the TV by HDMI cable. The external devices need to support HDMI & CEC Function (HDMI-CEC).

Connecting an external device through HDMI-CEC Function  >

Settings > **System** > **HDMI-CEC**

1. Set **HDMI-CEC** to On.
2. Connect an HDMI-CEC-compliant device to the TV.
3. Turn on the connected external device. The device is automatically connected to the TV. After connection is finished, you can access the menu of the connected device on your TV screen using your TV remote and control the device.

Note:

- HDMI cables must be used to connect HDMI CEC-compatible devices to your TV.
- The HDMI CEC feature of the connected device must be turned on.

- If you connect an HDMI device that is not HDMI CEC-compatible, all the HDMI-CEC control features do not work.
- Depending on the connected HDMI device, the HDMI-CEC Control feature may not work.
- The HDMI CEC feature are supported One Touch Play, Routing Control, System Standby, Device OSD Name Transfer, Remote Control Pass Through, Give Device Power Status, System Audio Control.

HDMI Device

Connect an HDMI cable from an external A/V equipment.

Some devices such as DVD player require HDMI signal to be set to output in the device's settings. Please consult your device user manual for instructions.

Please note that the HDMI connector provides both video and audio signals, it's not necessary to connect an audio cable.

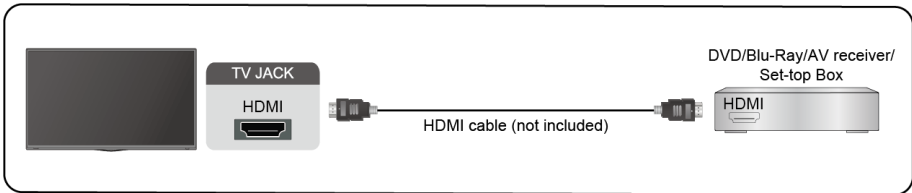

USB Device

Connect the USB devices such as hard drives, USB sticks and digital cameras for browsing photos, listening to music.

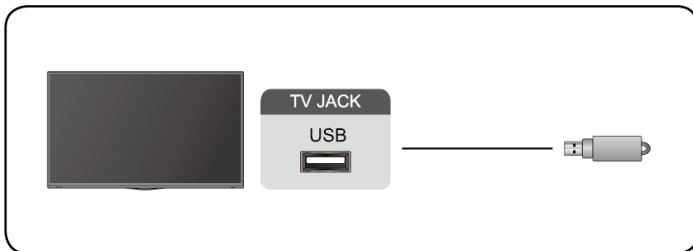

Support format: FAT32.

Multi-screen

Screen Sharing

Mirror content from your device to the TV.

INPUT > Screen Sharing

- Turn on the casting function of your Android/Windows10 device.
- Find the TV name in the searching list of your device and select it. Wait for the connection progress to complete and the content on your device will be displayed on the TV.

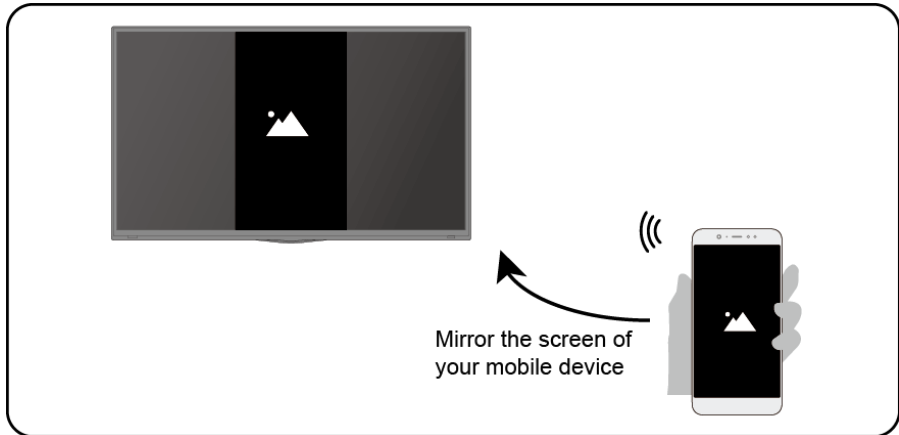

Note:

- Some Android devices may not support casting.

Content Sharing

Share media content, like videos, music or photos, from your device to the TV screen.

Before you use this function, turn on Content Sharing at  > **Settings** >

System > **Application Settings** > **Content Sharing**.

- Establishing Content Sharing connection between the TV and your device
 1. Turn on the content sharing function of your device.
 2. Find the TV name in the searching list of your device and select it.
 3. Wait for the connection progress to complete, and select the content you want to share

- Viewing media content of your device

Press **INPUT** button on your remote, and select a media content on the screen.

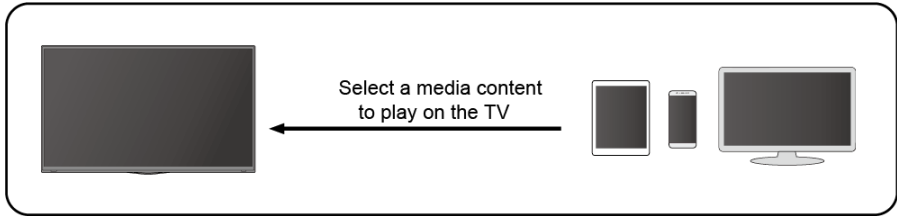

Note:

- Make sure your device and the TV are connected to the same network.
- Some devices may not support content sharing. If your device doesn't support content sharing, you can download an app that supports the function.
- If you want to mirror content from your device, go to **INPUT** > **Screen Sharing**.

Smart Functions

Media

Playing Media contents

 > **My Apps** > **Media**

By default, there are **Content Sharing** displayed on the Media screen. If your mobile device is connected to the TV, its name also appears on the Media screen.

Note:

- For more information about Content Sharing, refer to its detailed introduction.

 > **My Apps** > **Media** > **connected device**

Select the content you want to play on the screen, like pictures, videos and music.

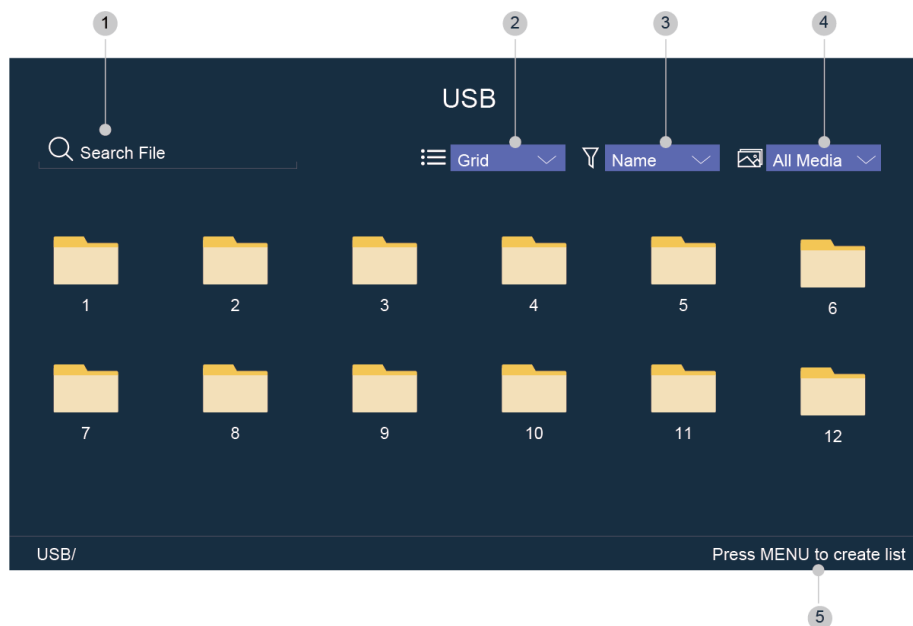

1 Input the content name you want to play.

2 Arrange the content list by **Grid**, **List**.



3 Arrange the content list by **Name**, **Date Modified**, **Size**.

4 Filter the content list by **All Media**, **Photo**, **Video**, **Music**.

5 Create a photo, music, or video playlist.

Playing background music during viewing pictures

You need to:

- Choose a picture to playback.
- Press  /  button to call out playbar.
- Select Background Music and choose your music to create a Music Playlist.
- Play the background music during viewing pictures.

Note:

- The TV may be support the following file formats:



Medium	File Format
Video	.MP4, .MOV, .MPG, .MPEG, .FLV
Picture	.jpg, .BMP, .PNG, .GIF
Music	.MP3, .AAC, .wav

- For more information about connection to other device, refer to the detailed introduction of each part.

Home

Getting familiar with the Home screen

Run the TV more conveniently by selecting the corresponding sections. Press  button.

- You can always view the current time at the top of the Home screen.
- If your TV is connected to the Internet through a wireless connection, then the icon  will be at the top right corner of the screen.
- Manage apps
Select the item you want to move, press  button to manage.

Search

Search the app you want.

Inputs

Select the input you want.

Settings

Display the Settings menu.

Notifications

Allow pop-up notifications to appear for useful information and events that occur with your TV.

- Select **Notifications** on the Home screen, and select **Settings** then display **Advertising, New Arrivals, Warnings And Legal Statements, System Message**, from which you can choose the types of notifications you would like to receive.

VIDAA Account

Sign in your VIDAA account.

A VIDAA account gives you all the best feature of your smart TV and always keeps it up to date.

Picture and Sound

Adjusting the Picture Quality

Adjust current picture mode to apply to all sources or just current source.

The menu is only for reference. The following modes may differ from the actual product.

Choosing a picture mode

 > **Settings** > **Picture** > **Picture Mode**

You can select the Picture Mode that provides the best viewing experience.

- **Standard**
- **Cinema Day**
- **Cinema Night**
- **Dynamic**
- **Sports**

Choosing a Aspect Ratio

 > **Settings** > **Picture** > **Aspect Ratio**

You can adjust the Aspect Ratio to stretch or zoom the picture.

- **Automatic**
- **16:9**
- **4:3**
- **Panoramic**
- **Movie Zoom**
- **Direct**

Choosing the Game Mode under ON/OFF

 > **Settings** > **Picture** > **Game Mode**

Optimised for PC or Games consoles. Reduces Input Lag and improves responsiveness.

Configuring advanced picture settings

 > **Settings** > **Picture** > **Picture Mode Settings**

Adjust display setting for each Picture Mode.

- **Apply Picture Settings**
- **Backlight**
- **Brightness**
- **Contrast**
- **Color Saturation**
- **Sharpness**
- **Adaptive Contrast**
- **Noise Reduction**
- **MPEG Noise Reduction**
- **Colour Temperature**
- **Expert Settings**
- **Overscan**
- **Reset Current Mode**

Adjusting the Sound Quality

Adjust current sound mode to apply to all sources or just current source.

The menu is only for reference. The following modes may differ from the actual product.

Choosing a sound mode

 > **Settings** > **Sound** > **Sound Mode**

You can select a favourite sound mode suitable for the content type or the listening environment.

- **Standard**
- **Theater**
- **Music**
- **Speech**
- **Late Night**
- **Sport**

 > **Settings** > **Sound** > **Headphone**

Set the sound out mode for headphones.

 > **Settings** > **Sound** > **Sound Mode Settings**

Adjust the audio settings of the TV: Apply Audio Settings/Equalizer/Wall Mount Setup/Auto Volume Control/Reset Current Mode.

 > **Settings** > **Sound** > **Speakers**

Select the speakers which you want to use.

System and Support

Setting Time

 > **Settings** > **System** > **Time**

Set the current time based on your location.

- **Time Format**

Set the time to display in a 12 or 24-hour format.

- **Date/Time**

Set the date and time.

- **Time Zone**

Set the time zone.

- **Daylight Savings**

Select whether to apply Daylight Savings Time to the TV.

Using the timer

 > **Settings** > **System** > **Timer Settings**

Adjust the timer settings to suit your preference.

- **Sleep Timer**

Set the sleep timer to automatically turn the TV Off within a specified time: Off, 15 Minutes, 30 Minutes, 60 Minutes, 90 Minutes, 120 Minutes, User Defined.

- **Power On Timer**

Set the clock for the time you want the TV to turn on automatically. You can set the time only once or set the time in specified date weekly.

- **Power Off Timer**

Set the clock for the time you want the TV to turn off automatically. You can set the time only once or set the time in specified date weekly.

- **Menu Timeout**

Set the amount of time that you would like for the menu to display: Off, 10s, 20s, 30s, 60s, 5min.

- **Auto Sleep**

Set the amount of time that you would like the TV to auto power off after a period of no activity : Off, 3H, 4H.

- **Auto Standby with No Signal**

TV will go to standby if there is no signal after the set time: Off, 15min.

Notification



> **Settings > System > Advanced Settings > Notifications**

Allow pop-up notifications to appear for useful information and events that occur with your TV, including: Advertising, New Arrivals, Warnings And Legal Statements and System message. You can enable/disable each of these notifications.



> **Notifications**

You can view the list of event messages generated by the TV. To delete all notifications, select **Clear All**.

Upgrade



> **Settings > Support > System Update**

Set your TV to receive the latest firmware.

- **Auto Firmware Upgrade**

Set your TV to automatically receive the latest firmware.

- **Check Firmware Upgrade**

Check to ensure that your TV has received the latest firmware.

Note: Please ensure your TV is connected to the Internet.

- **System App Auto Upgrade**

App auto upgrade will be done in the background. May need your confirmation on new Privacy Notices to complete upgrade in the progress.

- **Upgrade From USB**

Upgrade TV software from USB device.

Note:

- Please ensure the USB flash drive insert to USB2.0 port of the TV.
- The updating files must be available in root directory.
- The format of the USB must be FAT32 and the partition table type must be MBR.

E-Manual



> **Settings** > **Support** > **E-Manual**

Launch the E-Manual and get to know more about your TV: Live TV, Connection, Multi-screen, Smart Function, Picture and Sound, Accessibility and System, Troubleshooting, Using the E-Manual.

Hotel Mode

Hotel Mode

Press  on the remote control and select Settings

Press OK button to enter item Sound; press the UP/DOWN buttons to select Speakers and Press OK button to confirm your selection.

After into the sub-page, press UP/DOWN button to select Balance(no need to press OK button), then press 0548 on remote control and the Hotel Mode menu will display.

Press OK button to set the hotel Mode On

Press OK button again to set the Hotel Mode OFF.

MAINTENANCE

- Be sure to press STANDBY button to set the player to the standby mode and disconnect the power plug before maintaining the player.
- Wipe the player with a dry, soft cloth.
- If the surface is extremely dirty, wipe clean with a cloth which has been dipped in a weak soap-water solution and wrung out thoroughly, and then wipe again with a dry cloth.
- Never use alcohol, benzene, thinner, cleaning fluid or other chemicals. And do not use compressed air to remove dust.

WALL MOUNTING

- Contact a professional for assistance when wall mounting your TV. We are not responsible for any damage to the product or injury to yourself, if you mount the TV on your own.
- Do not wall mount the TV while TV is turned on. It may cause personal injury due to electric shock.
- Use standard M4*10mm screws (4 pieces) to mount this TV.

Back of your TV

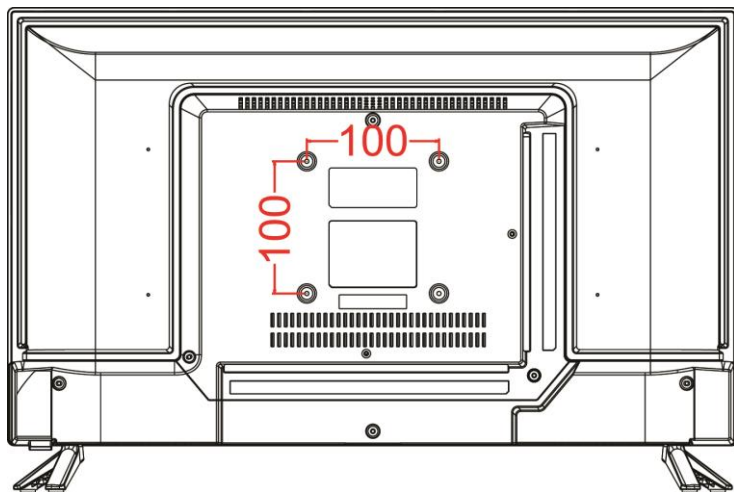

STAND INSTALLATION

Your TV is packaged with the Stand and the Cabinet separated. Before enjoying this TV, please carry out the Stand Installation according to the instructions below.

Step 1

Place the TV faced down on a soft cloth or cushion to prevent the panel from being damaged.

Step 2

Align the Stands with TV bottom in the correct position as per picture (2).

Step 3

Tighten the included screws with a screw driver.

NOTES:

- 1) Unplug the power plug first when installing or removing the TV Stand.
- 2) To avoid any damage to this TV, contact one or more partner for assistance when installing or removing the TV stand.

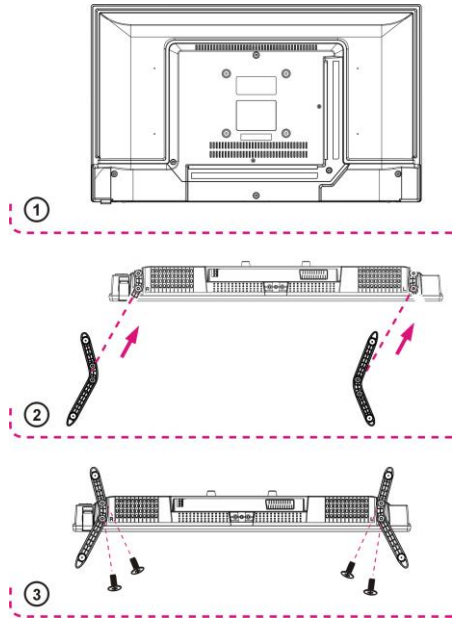

SPECIFICATIONS

Display Device	24 inch LED FHD TV
Resolution	1920×1080
Pixel Pitch	0.09052(H)×0.27156(V) mm
Luminance	180 cd/m ² (+/-10%)
Contrast Ratio	3000:1
Aspect Ratio	16:9
Response Time	21 ms
Viewing Angle	178(H)/178(V)
Visible Range	521.3952(H)×293.2848(V) mm

Tuner:

Analogue tuner PAL

DVBT/T2 and DVB-C HD tuner

DVB-S/S2 HD tuner

Automatic channel search

LCN function (logical channel numbering)

EPG (electronic program guide)

USB input

USB:

Supported formats:

Video: MP4, MOV, MPG, MPEG, FLV

Photo: JPG, BMP, PNG, GIF

Music: MP3, AAC, WAV

Inputs / Outputs

Input: HDMI x3, CVBS&LR, LAN, CI

Antenna 75 ohms input (DTV/ATV)

Satellite antenna LBN input (DVB-S2)

Headphones/earphones jack 3,5mm

Support bases included

Video Input

CVBS

Video System: PAL/NTSC

Video Level: 1.0Vp-p±10%

HDMI

480i,480p,720p,1080i,1080p

Double power supply system: AC 100 / 240V (50 / 60Hz) - DC 12V

Operation temperature -5° to 35°

Unit dimensions: 33.1 (H) x 55.3 (L) x 6.7 (D) cm

Dimensions with stand: 36.7 (H) x 55.3(L) x 16.5 (D) cm

Weight with stand: Approx. 2.17 kg

Specifications are subject to change without notice.

GENERAL TROUBLESHOOTING

Check the following points before assuming malfunctions of this unit:

Symptom	Remedy
No power.	Insert the power plug securely into the power outlet.
No picture.	Ensure that the equipment is connected properly.
<ul style="list-style-type: none"> ● No sound. ● Distorted sound. 	<ul style="list-style-type: none"> ● Ensure that the equipment is connected properly. ● Ensure that the input setting for the TV and stereo system are correct. ● Adjust the master volume to a suitable volume by pressing VOL+/VOL- button.
No operations can be performed with the remote control unit.	<ul style="list-style-type: none"> ● Check the batteries are installed with the correct polarities. ● The batteries are exhausted: Replace them with new ones. ● Point remote control at the remote control sensor and operate it again. ● Operate the remote control unit at a distance of no more than 6m from the remote control sensor. ● Remove the obstacles between the remote control and remote control sensor.
No key operation (by the main unit and/or the remote control unit) is effective.	Disconnect the power plug and then reconnect it. (The TV may not be operating properly due to lightning, static electricity or some other factors.)
Symptom(TV)	Remedy
No or poor picture.	<ul style="list-style-type: none"> ● Adjust antenna or use an external antenna. ● Relocate the unit near a window (if inside a building). ● Move units away from this product that causes interference. ● Do Auto Tuning again. ● reset to factory settings.
No sound or poor sound.	<ul style="list-style-type: none"> ● Check the audio settings. ● Press MUTE button on remote control to cancel mute function. ● Unplug the headphone.
Noise or other interface.	Electronic equipment near the unit is causing interface. Relocate the unit or move the equipment.

INFORMATION TO USERS OF DOMESTIC EQUIPMENT



Pursuant to Art. 25, Paragraph 1 of the Legislative Act N. 49 14th March 2014, "Implement of the Directives 2011/65 / EU and 2012/19 / EU concerning the reduction of the use of hazardous substances in electrical and electronic equipment, as well as waste disposal".

The crossed bin symbol on the appliance or on its packaging indicates that the product at the end of its useful life must be collected separately from other waste. The user must, therefore, dispose the equipment at the end of its life to the appropriate electronic and electro technical waste centers, or return it to the retailer at the time of purchase of a new type of equivalent equipment, one by one.

Appropriate separate disposal for the subsequent start-up of the disused equipment for recycling, treatment and compatible environmental disposal helps to avoid possible negative effects on the environment and health and favours the re-use and / or recycling of the materials it is composed the equipment.

The illegal disposal of the product by the user involves the application of the penalties referred to in current laws.

Any rechargeable batteries or rechargeable batteries contained in the device must be disposed separately in the appropriate expired batteries bins.

Battery disposal



Disposal of expired batteries must take place at the appropriate recycling centers or according to local authority. Batteries in compliance with the 2013/56 / EC directive.

MAJESTIC

TV 24" TFT LED
 MOD. ST24VD
 ALIMENTAZIONE: AC 100-240V~50/60Hz 60W DC12V
 CONSUMO IN STANDBY: MAX. 0.5W
 USB: 5V = 500mA

NEW MAJESTIC S.p.A.
 Via Rossi Martini, 41
 26013 CREMA (CR)
 ITALY
 MADE IN EU

 = Class II, double insulation

 = WEEE Logo (Waste of electrical and electronic equipments)



 = Indoor use



NEW MAJESTIC S.p.A.
 Via Rossi Martini, 41
 26013 CREMA (CR)
 ITALY
 MADE IN EU

 = Battery disposal

MAJESTIC

NEW MAJESTIC S.P.A.
 Via Rossi Martini 41
 26013 CREMA (CR)

MADE IN EU

